

METALKA MAJUR KATALOG PROIZVODA • PRODUCT CATALOGUE 2022



 METALKA
MAJUR

KATALOG PROIZVODA
PRODUCT CATALOGUE



Metalka Majur d.o.o.
Vihorska 9
35000 Jagodina, Srbija
Tel: +381 35 / 200 040
+381 35 / 200 050
Fax: +381 35 / 200 022
office@metalka-majur.com
www.metalka-majur.com



 METALKA
MAJUR

Sadržaj:

03 : NATURE
18 : KOMBO
33 : KOMBO 60
34 : KOMBO LED
36 : PREMIJER PLUS
44 : STATUS
52 : ROYAL
60 : ROYAL EXCLUSIVE
66 : EMPORIO
70 : HAPPY
76 : SET O OG
82 : MINI OG
86 : RAZVODNE TABLE
92 : INSTALACIONE KUTIJE
93 : ELEKTRO PRIBOR
94 : PRENOSNE PRIKLJUČNICE
98 : OFFICE SERIJA
104 : VENTILATORI
106 : UPUTSTVO ZA MONTAŽU

Contents:

03 : NATURE
18 : KOMBO
33 : KOMBO60
34 : KOMBO LED
36 : PREMIJER PLUS
44 : STATUS
52 : ROYAL
60 : ROYAL EXCLUSIVE
66 : EMPORIO
70 : HAPPY
76 : SET O OG
82 : MINI OG
86 : DISTRIBUTION PANELS
92 : JUNCTION BOXES
93 : ELECTRICAL ACCESSORIES
94 : PORTABLE SOCKET
98 : OFFICE SERIA
104 : BATHROOM FAN
106 : MOUNTING INSTRUCTIONS



Preduzeće Metalka Majur osnovano je 1986. godine i tokom tri decenije postojanja od male zanatske radionice razvilo se u modernu evropsku kompaniju. Metalka Majur je 2020. godine promenila vlasničku strukturu i danas zapošljava 100 radnika. Metalka Majur je tržišni lider u proizvodnji elektro galanterije u regionu Jugoistočne Evrope. Proizvodi iz programa Metalke Majur prisutni su kako na evropskom tako i na tržištu Bliskog istoka, a konstantno se radi na osvajanju novih tržišta. Proizvodni program Metalke Majur može se grupisati u nekoliko celina:

- Sklopke i priključnice za ugradnju u zid
- Sklopke i priključnice za ugradnju na zid
- Modularni program sklopki i priključnica
- Modularna LED rasveta
- Razvodne table
- Razvodne kutije
- Elektroinstalacioni pribor

Vizija Metalke Majur je da bude značajna regionalna kompanija u Jugoistočnoj Evropi. Misija Metalke Majur satkana je u kvalitetu i lepoti detalja kojim korisnik pokreće svoje izvore energije, toplote i svetlosti.

The company Metalka Majur was founded in 1986. For almost three decades of work it has developed from a small craft workshop into modern European company. Metalka Majur changed its ownership structure in 2020 and today employs 100 workers.

Metalka Majur is a market leader in production of electrical installation materials in South-East Europe. Products from the Metalka Majur are present in both the European and the Middle East market.

Production range of Metalka Majur can be divided in several groups:

- Switches and socket-outlets for flush assembling
- Switches and socket-outlets for surface assembling
- Modular program of switches and socket-outlets
- Modular LED lighting
- Distribution panels for MCBs
- Junction boxes
- Electrical accessories

Metalka Majur's vision is to be the most important regional company in South-East Europe. Mission of Metalka Majur is contained in the quality and beauty of detail which serve to the customer to trigger his sources of energy, heat and light.

client support center



**CALL
OUR
CLIENT
SUPPORT CENTER**



Contact for Client support center
tehnicka.podrska@metalka-majur.com
Tel: +381 35 / 200 011

Primenjujući evropske standarde u potpunom procesu stvaranja proizvoda Metalka Majur je zauzela dobru startnu poziciju za utakmicu na evropskom tržištu. Kvalitet je potvrđen u Rusiji (GOST), Hrvatskoj (ZIK) i Srbiji (Institut za nuklearne nauke Vinča).

By applying European standards in complete process of making products, Metalka Majur has obtained a good starting position for competing on the European market. As the confirmation of quality, there are many quality certificates issued by European certification bodies: GOST (Russia), Croatia (ZIK) and Serbia (Institute for Nuclear Sciences Vinca).



Beauty is
in details
...

Rezultat postavljanja razvoja Metalke Majur u funkciju stvaranja kvalitetnih proizvoda su znaci kvaliteta:
Results of putting development of Metalka Majur in function of creating high quality products are signs of quality:



Srpski znak usaglašenosti;
Serbian mark of conformity;



Znak kvaliteta potvrđen u institutu "Rostest", Rusija;
Quality mark confirmed the institute "Rostest", Russia;



Znak kvaliteta potvrđen u Zavodu za ispitivanje kvaliteta ZIK, Hrvatska;
Quality mark confirmed in the Department of quality testing ZIK, Croatia;

CE znak na proizvodu govori da proizvod ispunjava zahteve direktiva EU i da se na njemu sprovode postupci provere usaglašenosti.

Da bi osigurala stabilnost kvaliteta u proizvodnji, Metalka Majur je 1996. godine uvela i organizovala svoj rad po sistemu menadžmenta kvalitetom ISO 9001. Od tada, pa do današnjeg dana, sistem menadžmenta kvalitetom se uspešno održava, što dokazuje sertifikat izdat od strane JUQS-a i IQNet-a.

CE mark on a product means that the product meets requirements of EU directives and that it undergoes procedures of compliance controls. Quality system certificates (YUQS, IQNet) confirm the repeatability of quality.



CE ISO 9001



nature

WOOD • ALU • PLEXI • CORIAN • PLASTIC



Lako se uklapa u različite tipove enterijera
Easily fits into different types of interior

Stepen zaštite: IP20
Protection level: IP20

Priključnice sa telom od keramike ili polikarbonata
Socket with ceramic or polycarbonate base

Sklopke sa vijčanim i bezvijčanim priključkom
Switches with screw and screwless connection

IEC 60884-1 priključnice / socket; IEC 60669-1 sklopke / switch

bv bezvijčana veza
screwless connection

jk jezgro od keramike
ceramic body

vv vijčana veza
connection with screws

jp jezgro od polikarbonata
polycarbonate body

 Prikluči se...

nature modules



Ukrasni okvir
Decorative cover plate

+



Modul
Modul

=

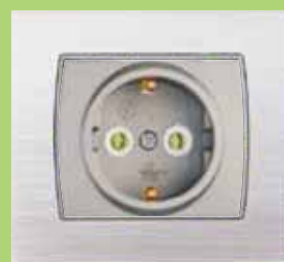

Finalni proizvod
Final product

BOJE MODULA • COLOUR OPTIONS



Bela
White



Slonova kost
Ivory



Srebrna
Silver



Zlatna
Gold



Crna
Black



Jednopolna sklopka
Single-pole switch
10AX/250V; IP 20

Broj artikla / Article No.:

bv **wv**

<input type="checkbox"/> 19.01.101	19.01.121
<input type="checkbox"/> 19.19.101	19.19.121
<input type="checkbox"/> 19.74.101	19.74.121
<input type="checkbox"/> 19.71.101	19.71.121
<input type="checkbox"/> 19.75.101	19.75.121

Pakovanje / Pack:
20 kom / pcs.

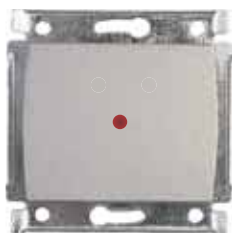

Jednopolna sklopka sa signalnom sijalicom
Single-pole switch with pilot light
10AX/250V; IP 20

Broj artikla / Article No.:

bv **wv**

<input type="checkbox"/> 19.01.107	19.01.127
<input type="checkbox"/> 19.19.107	19.19.127
<input type="checkbox"/> 19.74.107	19.74.127
<input type="checkbox"/> 19.71.107	19.71.127
<input type="checkbox"/> 19.75.107	19.75.127

Pakovanje / Pack:
20 kom / pcs.



Serijska sklopka
Two-circuit switch
10AX/250V; IP 20

Broj artikla / Article No.:

bv **wv**

<input type="checkbox"/> 19.01.104	19.01.124
<input type="checkbox"/> 19.19.104	19.19.124
<input type="checkbox"/> 19.74.104	19.74.124
<input type="checkbox"/> 19.71.104	19.71.124
<input type="checkbox"/> 19.75.104	19.75.124

Pakovanje / Pack:
20 kom / pcs.

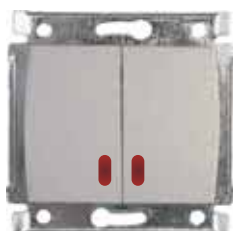

Serijska sklopka sa signalnim sijalicama
Two-circuit switch with pilot lights
10AX/250V; IP 20

Broj artikla / Article No.:

bv **wv**

<input type="checkbox"/> 19.01.119	19.01.139
<input type="checkbox"/> 19.19.119	19.19.139
<input type="checkbox"/> 19.74.119	19.74.139
<input type="checkbox"/> 19.71.119	19.71.139
<input type="checkbox"/> 19.75.119	19.75.139

Pakovanje / Pack:
20 kom / pcs.



Naizmjenična sklopka
Two-way switch
10AX/250V; IP 20

Broj artikla / Article No.:

bv **wv**

<input type="checkbox"/> 19.01.105	19.01.125
<input type="checkbox"/> 19.19.105	19.19.125
<input type="checkbox"/> 19.74.105	19.74.125
<input type="checkbox"/> 19.71.105	19.71.125
<input type="checkbox"/> 19.75.105	19.75.125

Pakovanje / Pack:
20 kom / pcs.



Unakrsna sklopka
Intermediate switch
10AX/250V; IP 20

Broj artikla / Article No.:

bv **wv**

<input type="checkbox"/> 19.01.106	19.01.126
<input type="checkbox"/> 19.19.106	19.19.126
<input type="checkbox"/> 19.74.106	19.74.126
<input type="checkbox"/> 19.71.106	19.71.126
<input type="checkbox"/> 19.75.106	19.75.126

Pakovanje / Pack:
20 kom / pcs.



Taster svetla
Light push-button
10AX/250V; IP 20

Broj artikla / Article No.:

bv **wv**

<input type="checkbox"/> 19.01.111	19.01.131
<input type="checkbox"/> 19.19.111	19.19.131
<input type="checkbox"/> 19.74.111	19.74.131
<input type="checkbox"/> 19.71.111	19.71.131
<input type="checkbox"/> 19.75.111	19.75.131

Pakovanje / Pack:
20 kom / pcs.

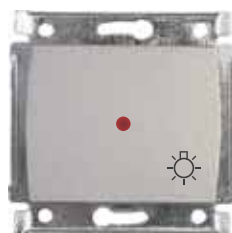

Taster svetla sa signalnom sijalicom
Light push-button with pilot light
10AX/250V; IP 20

Broj artikla / Article No.:

bv **wv**

<input type="checkbox"/> 19.01.113	19.01.133
<input type="checkbox"/> 19.19.113	19.19.133
<input type="checkbox"/> 19.74.113	19.74.133
<input type="checkbox"/> 19.71.113	19.71.133
<input type="checkbox"/> 19.75.113	19.75.133

Pakovanje / Pack:
20 kom / pcs.



Taster zvona
Bell push-button
10AX/250V; IP 20

Broj artikla / Article No.:

bv **wv**

<input type="checkbox"/> 19.01.110	19.01.130
<input type="checkbox"/> 19.19.110	19.19.130
<input type="checkbox"/> 19.74.110	19.74.130
<input type="checkbox"/> 19.71.110	19.71.130
<input type="checkbox"/> 19.75.110	19.75.130

Pakovanje / Pack:
20 kom / pcs.

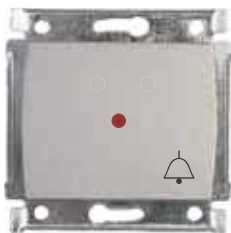

Taster zvona sa signalnom sijalicom
Bell push-button with pilot light
10AX/250V; IP 20

Broj artikla / Article No.:

bv vv

<input type="checkbox"/> 19.01.112	<input type="checkbox"/> 19.01.132
<input type="checkbox"/> 19.19.112	<input type="checkbox"/> 19.19.132
<input type="checkbox"/> 19.74.112	<input type="checkbox"/> 19.74.132
<input type="checkbox"/> 19.71.112	<input type="checkbox"/> 19.71.132
<input type="checkbox"/> 19.75.112	<input type="checkbox"/> 19.75.132

Pakovanje / Pack:
20 kom / pcs.



Taster za roletne
Blind control button
10A/250V; IP 20

Broj artikla / Article No.:

bv vv

<input type="checkbox"/> 19.01.118	<input type="checkbox"/> 19.01.138
<input type="checkbox"/> 19.19.118	<input type="checkbox"/> 19.19.138
<input type="checkbox"/> 19.74.118	<input type="checkbox"/> 19.74.138
<input type="checkbox"/> 19.71.118	<input type="checkbox"/> 19.71.138
<input type="checkbox"/> 19.75.118	<input type="checkbox"/> 19.75.138

Pakovanje / Pack:
20 kom / pcs.



Jednopolna sklopka sa preklopnikom i signalnom sijalicom
Single-pole switch with tumbler switch and pilot light
16AX/250V; IP 20

Broj artikla / Article No.:

jk

<input type="checkbox"/> 19.01.145
<input type="checkbox"/> 19.19.145
<input type="checkbox"/> 19.74.145
<input type="checkbox"/> 19.71.145
<input type="checkbox"/> 19.75.145

Pakovanje / Pack:
20 kom / pcs.



Taster SOS sa signalnom sijalicom
SOS push-button with pilot light
10A/250V; IP 20

Broj artikla / Article No.:

bv vv

<input type="checkbox"/> 19.01.115	<input type="checkbox"/> 19.01.135
<input type="checkbox"/> 19.19.115	<input type="checkbox"/> 19.19.135
<input type="checkbox"/> 19.74.115	<input type="checkbox"/> 19.74.135
<input type="checkbox"/> 19.71.115	<input type="checkbox"/> 19.71.135
<input type="checkbox"/> 19.75.115	<input type="checkbox"/> 19.75.135

Pakovanje / Pack:
20 kom / pcs.



Regulator svetla
(za halogene i sijalice sa užarenim vlaknom)
Dimmer switch
(Only for incandescent bulbs and halogen bulbs)

Broj artikla / Article No.:

60-800W,230V 100-500W,230V, CE

<input type="checkbox"/> 19.01.242	<input type="checkbox"/> 19.01.342
<input type="checkbox"/> 19.19.242	<input type="checkbox"/> 19.19.342
<input type="checkbox"/> 19.74.242	<input type="checkbox"/> 19.74.342
<input type="checkbox"/> 19.71.242	<input type="checkbox"/> 19.71.342
<input type="checkbox"/> 19.75.242	<input type="checkbox"/> 19.75.342

Pakovanje / Pack:
16 kom / pcs.



Potezni taster SOS
SOS push-button
cord operated
10A/250V; IP 20

Broj artikla / Article No.:

bv vv

<input type="checkbox"/> 19.01.120	<input type="checkbox"/> 19.01.140
<input type="checkbox"/> 19.19.120	<input type="checkbox"/> 19.19.140
<input type="checkbox"/> 19.74.120	<input type="checkbox"/> 19.74.140
<input type="checkbox"/> 19.71.120	<input type="checkbox"/> 19.71.140
<input type="checkbox"/> 19.75.120	<input type="checkbox"/> 19.75.140

Pakovanje / Pack:
20 kom / pcs.



LED Regulator svetla
(3-250W, 230V~)
LED Dimmer
(3-250W, 230V~)

Broj artikla / Article No.:

3-250W,230V

<input type="checkbox"/> 19.01.442
<input type="checkbox"/> 19.19.442
<input type="checkbox"/> 19.74.442
<input type="checkbox"/> 19.71.442
<input type="checkbox"/> 19.75.442

Pakovanje / Pack:
16 kom / pcs.



Dvopolna priključnica
Two-pole socket-outlet
16A/250V; IP 20

Broj artikla / Article No.:

jk jp

<input type="checkbox"/> 19.01.150	<input type="checkbox"/> 19.01.151
<input type="checkbox"/> 19.19.150	<input type="checkbox"/> 19.19.151
<input type="checkbox"/> 19.74.150	<input type="checkbox"/> 19.74.151
<input type="checkbox"/> 19.71.150	<input type="checkbox"/> 19.71.151
<input type="checkbox"/> 19.75.150	<input type="checkbox"/> 19.75.151

Pakovanje / Pack:
20 kom / pcs.



Dvopolna priključnica sa zaštitnim elementom
Two-pole socket-outlet with protection
16A/250V; IP 20

Broj artikla / Article No.:

jp

<input type="checkbox"/> 19.01.152
<input type="checkbox"/> 19.19.152
<input type="checkbox"/> 19.74.152
<input type="checkbox"/> 19.71.152
<input type="checkbox"/> 19.75.152

Pakovanje / Pack:
20 kom / pcs.

bv bezvijčana veza
screwless connection

vv vijčana veza
connection with screws

jk jezgro od keramike
ceramic body

jp jezgro od polikarbonata
polycarbonate body



Dvopolna priključnica sa poklopcem
Two-pole socket-outlet with cover
16A/250V; IP 20

Broj artikla / Article No.:

jk **jp**

- | | | |
|--------------------------|-----------|-----------|
| <input type="checkbox"/> | 19.01.158 | 19.01.153 |
| <input type="checkbox"/> | 19.19.158 | 19.19.153 |
| <input type="checkbox"/> | 19.74.158 | 19.74.153 |
| <input type="checkbox"/> | 19.71.158 | 19.71.153 |
| <input type="checkbox"/> | 19.75.158 | 19.75.153 |

Pakovanje / Pack:
20 kom / pcs.



Dvopolna priključnica sa transparentnim poklopcem
Two-pole socket-outlet with transparent cover
16A/250V; IP 20

Broj artikla / Article No.:

jk **jp**

- | | | |
|--------------------------|-----------|-----------|
| <input type="checkbox"/> | 19.01.168 | 19.01.163 |
| <input type="checkbox"/> | 19.19.168 | 19.19.163 |
| <input type="checkbox"/> | 19.74.168 | 19.74.163 |
| <input type="checkbox"/> | 19.71.168 | 19.71.163 |
| <input type="checkbox"/> | 19.75.168 | 19.75.163 |

Pakovanje / Pack:
20 kom / pcs.



Dvopolna priključnica sa poklopcem i zaštitnim elementom
Two-pole socket-outlet with cover and protection
16A/250V; IP 20

Broj artikla / Article No.:

jp

- | | |
|--------------------------|-----------|
| <input type="checkbox"/> | 19.01.154 |
| <input type="checkbox"/> | 19.19.154 |
| <input type="checkbox"/> | 19.74.154 |
| <input type="checkbox"/> | 19.71.154 |
| <input type="checkbox"/> | 19.75.154 |

Pakovanje / Pack:
20 kom / pcs.



Dvopolna priklj. sa transp. poklopcem i zaštitnim elementom
Two-pole socket-outlet with transparent cover and protection
16A/250V; IP 20

Broj artikla / Article No.:

jp

- | | |
|--------------------------|-----------|
| <input type="checkbox"/> | 19.01.164 |
| <input type="checkbox"/> | 19.19.164 |
| <input type="checkbox"/> | 19.74.164 |
| <input type="checkbox"/> | 19.71.164 |
| <input type="checkbox"/> | 19.75.164 |

Pakovanje / Pack:
20 kom / pcs.



Dvostruka priključnica
Double two-pole socket-outlet
16A/250V; IP 20

Broj artikla / Article No.:

jk **jp**

- | | | |
|--------------------------|-----------|-----------|
| <input type="checkbox"/> | 19.01.157 | 19.01.155 |
| <input type="checkbox"/> | 19.19.157 | 19.19.155 |
| <input type="checkbox"/> | 19.74.157 | 19.74.155 |
| <input type="checkbox"/> | 19.71.157 | 19.71.155 |
| <input type="checkbox"/> | 19.75.157 | 19.75.155 |

Pakovanje / Pack:
12 kom / pcs.



Trofazna priključnica
Three-pole socket-outlet
16A/440V; IP 20

Broj artikla / Article No.:

jk

- | | |
|--------------------------|-----------|
| <input type="checkbox"/> | 19.01.159 |
| <input type="checkbox"/> | 19.19.159 |
| <input type="checkbox"/> | 19.74.159 |
| <input type="checkbox"/> | 19.71.159 |
| <input type="checkbox"/> | 19.75.159 |

Pakovanje / Pack:
16 kom / pcs.



Telefonska priključnica RJ12 6/4 sa dva modula 623K, IP 20
Telephone socket RJ12 6/4 with two modules 623K, IP 20

Broj artikla / Article No.:

bv **bv**

- | | | |
|--------------------------|-----------|-----------|
| <input type="checkbox"/> | 19.01.171 | 19.01.172 |
| <input type="checkbox"/> | 19.19.171 | 19.19.172 |
| <input type="checkbox"/> | 19.74.171 | 19.74.172 |
| <input type="checkbox"/> | 19.71.171 | 19.71.172 |
| <input type="checkbox"/> | 19.75.171 | 19.75.172 |

Pakovanje / Pack:
24 kom / pcs.



Komunikaciona priključnica RJ45 8/8 sa dva modula Cat6 UTP, IP 20
Communication socket with two modules Cat6 UTP, IP 20

Broj artikla / Article No.:

jk **jk**

- | | | |
|--------------------------|-----------|-----------|
| <input type="checkbox"/> | 19.01.177 | 19.01.178 |
| <input type="checkbox"/> | 19.19.177 | 19.19.178 |
| <input type="checkbox"/> | 19.74.177 | 19.74.178 |
| <input type="checkbox"/> | 19.71.177 | 19.71.178 |
| <input type="checkbox"/> | 19.75.177 | 19.75.178 |

Pakovanje / Pack:
24 kom / pcs.



TV priključnica sa jednim modulom, IP 20
TV aerial socket with one module, IP 20

Broj artikla / Article No.:

prolazna / feed through **završna / terminal**

- | | | |
|--------------------------|-----------|-----------|
| <input type="checkbox"/> | 19.01.188 | 19.01.190 |
| <input type="checkbox"/> | 19.19.188 | 19.19.190 |
| <input type="checkbox"/> | 19.74.188 | 19.74.190 |
| <input type="checkbox"/> | 19.71.188 | 19.71.190 |
| <input type="checkbox"/> | 19.75.188 | 19.75.190 |

Pakovanje / Pack:
24 kom / pcs.



TV priključnica sa dva modula, IP 20
TV aerial socket with two modules, IP 20

Broj artikla / Article No.:

Prolazno završna / feed through & terminal **završna / terminal**

- | | | |
|--------------------------|-----------|-----------|
| <input type="checkbox"/> | 19.01.192 | 19.01.191 |
| <input type="checkbox"/> | 19.19.192 | 19.19.191 |
| <input type="checkbox"/> | 19.74.192 | 19.74.191 |
| <input type="checkbox"/> | 19.71.192 | 19.71.191 |
| <input type="checkbox"/> | 19.75.192 | 19.75.191 |

Pakovanje / Pack:
24 kom / pcs.

nature



WOOD
decorative
frame





Ukrasni okvir orah
Decorative frame walnut



Ukrasni okvir bambus
Decorative frame bamboo

Broj artikla / Article No.:

- 19.53.001 (1M, 24 pcs.)
- 19.53.002 (2M, 12 pcs.)
- 19.53.003 (3M, 12 pcs.)
- 19.53.004 (4M, 12 pcs.)
- 19.53.005 (TP, 12 pcs.)
- 19.53.006 (DP, 12 pcs.)

Broj artikla / Article No.:

- 19.54.001 (1M, 24 pcs.)
- 19.54.002 (2M, 12 pcs.)
- 19.54.003 (3M, 12 pcs.)
- 19.54.004 (4M, 12 pcs.)
- 19.54.005 (TP, 12 pcs.)
- 19.54.006 (DP, 12 pcs.)

TP za trofaznu priključnicu
for tree-pole socket-outlet

DP za dvostruku priključnicu
for double two-pole socket-outlet

nature



alu
decorative
frame





Ukrasni okvir srebro
Decorative frame silver

Broj artikla / Article No.:

- 19.24.001 (1M, 24 pcs.)
- 19.24.002 (2M, 12 pcs.)
- 19.24.003 (3M, 12 pcs.)
- 19.24.004 (4M, 12 pcs.)
- 19.24.005 (TP, 12 pcs.)
- 19.24.006 (DP, 12 pcs.)



Ukrasni okvir bronza
Decorative frame bronze

Broj artikla / Article No.:

- 19.22.001 (1M, 24 pcs.)
- 19.22.002 (2M, 12 pcs.)
- 19.22.003 (3M, 12 pcs.)
- 19.22.004 (4M, 12 pcs.)
- 19.22.005 (TP, 12 pcs.)
- 19.22.006 (DP, 12 pcs.)



Ukrasni okvir champagne
Decorative frame champagne

Broj artikla / Article No.:

- 19.25.001 (1M, 24 pcs.)
- 19.25.002 (2M, 12 pcs.)
- 19.25.003 (3M, 12 pcs.)
- 19.25.004 (4M, 12 pcs.)
- 19.25.005 (TP, 12 pcs.)
- 19.25.006 (DP, 12 pcs.)



Ukrasni okvir crni
Decorative frame black

Broj artikla / Article No.:

- 19.23.001 (1M, 24 pcs.)
- 19.23.002 (2M, 12 pcs.)
- 19.23.003 (3M, 12 pcs.)
- 19.23.004 (4M, 12 pcs.)
- 19.23.005 (TP, 12 pcs.)
- 19.23.006 (DP, 12 pcs.)

TP za trofaznu priključnicu
for tree-pole socket-outlet

DP za dvostruku priključnicu
for double two-pole socket-outlet

nature

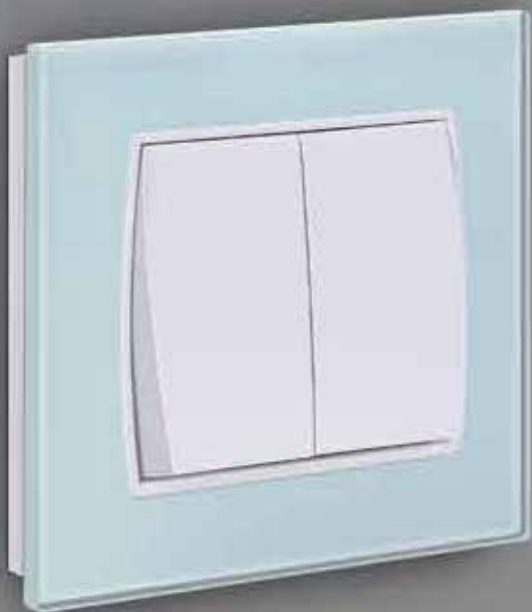







PLEXI
decorative
frame





Ukrasni okvir beli
Decorative frame white







Broj artikla / Article No.:

-  19.81.001 (1M, 24 pcs.)
-  19.81.002 (2M, 12 pcs.)
-  19.81.003 (3M, 12 pcs.)
-  19.81.004 (4M, 12 pcs.)
-  19.81.005 (TP, 12 pcs.)
-  19.81.006 (DP, 12 pcs.)



Ukrasni okvir tirkiz
Decorative frame turquoise





Broj artikla / Article No.:

-  19.82.001 (1M, 24 pcs.)
-  19.82.002 (2M, 12 pcs.)
-  19.82.003 (3M, 12 pcs.)
-  19.82.004 (4M, 12 pcs.)
-  19.82.005 (TP, 12 pcs.)
-  19.82.006 (DP, 12 pcs.)



Ukrasni okvir srebrni
Decorative frame silver

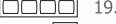





Broj artikla / Article No.:

-  19.84.001 (1M, 24 pcs.)
-  19.84.002 (2M, 12 pcs.)
-  19.84.003 (3M, 12 pcs.)
-  19.84.004 (4M, 12 pcs.)
-  19.84.005 (TP, 12 pcs.)
-  19.84.006 (DP, 12 pcs.)



Ukrasni okvir šampanj
Decorative frame champagne







Broj artikla / Article No.:

-  19.83.001 (1M, 24 pcs.)
-  19.83.002 (2M, 12 pcs.)
-  19.83.003 (3M, 12 pcs.)
-  19.83.004 (4M, 12 pcs.)
-  19.83.005 (TP, 12 pcs.)
-  19.83.006 (DP, 12 pcs.)



Ukrasni okvir crni mat
Decorative frame black glossless







Broj artikla / Article No.:

-  19.85.001 (1M, 24 pcs.)
-  19.85.002 (2M, 12 pcs.)
-  19.85.003 (3M, 12 pcs.)
-  19.85.004 (4M, 12 pcs.)
-  19.85.005 (TP, 12 pcs.)
-  19.85.006 (DP, 12 pcs.)



Ukrasni okvir crni sjaj
Decorative frame black gloss

Broj artikla / Article No.:

-  19.86.001 (1M, 24 pcs.)
-  19.86.002 (2M, 12 pcs.)
-  19.86.003 (3M, 12 pcs.)
-  19.86.004 (4M, 12 pcs.)
-  19.86.005 (TP, 12 pcs.)
-  19.86.006 (DP, 12 pcs.)

nature



corian
decorative
frame

















Ukrasni okvir corian beli
Decorative frame corian white

Ukrasni okvir corian sivi
Decorative frame corian silver

Broj artikla / Article No.:

Broj artikla / Article No.:

-  19.61.001 (1M, 24 pcs.)
-  19.61.002 (2M, 12 pcs.)
-  19.61.003 (3M, 12 pcs.)
-  19.61.004 (4M, 12 pcs.)
-  19.61.005 (TP, 12 pcs.)
-  19.61.006 (DP, 12 pcs.)

-  19.64.001 (1M, 24 pcs.)
-  19.64.002 (2M, 12 pcs.)
-  19.64.003 (3M, 12 pcs.)
-  19.64.004 (4M, 12 pcs.)
-  19.64.005 (TP, 12 pcs.)
-  19.64.006 (DP, 12 pcs.)

TP za trofaznu priključnicu
for tree-pole socket-outlet

DP za dvostruku priključnicu
for double two-pole socket-outlet

nature

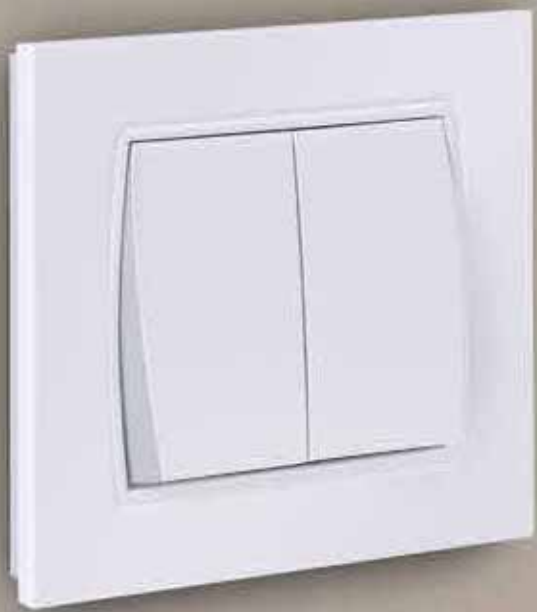





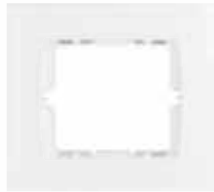

plastic
decorative
frame





Ukrasni okvir beli
Decorative frame white





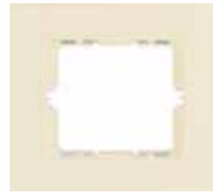

Broj artikla / Article No.:

-  19.01.001 (1M, 24 pcs.)
-  19.01.002 (2M, 12 pcs.)
-  19.01.003 (3M, 12 pcs.)
-  19.01.004 (4M, 12 pcs.)
-  19.01.005 (TP, 12 pcs.)
-  19.01.006 (DP, 12 pcs.)



Ukrasni okvir slonova kost
Decorative frame ivory







Broj artikla / Article No.:

-  19.19.001 (1M, 24 pcs.)
-  19.19.002 (2M, 12 pcs.)
-  19.19.003 (3M, 12 pcs.)
-  19.19.004 (4M, 12 pcs.)
-  19.19.005 (TP, 12 pcs.)
-  19.19.006 (DP, 12 pcs.)



Ukrasni okvir srebro
Decorative frame silver







Broj artikla / Article No.:

-  19.74.001 (1M, 24 pcs.)
-  19.74.002 (2M, 12 pcs.)
-  19.74.003 (3M, 12 pcs.)
-  19.74.004 (4M, 12 pcs.)
-  19.74.005 (TP, 12 pcs.)
-  19.74.006 (DP, 12 pcs.)



Ukrasni okvir zlato
Decorative frame gold







Broj artikla / Article No.:

-  19.71.001 (1M, 24 pcs.)
-  19.71.002 (2M, 12 pcs.)
-  19.71.003 (3M, 12 pcs.)
-  19.71.004 (4M, 12 pcs.)
-  19.71.005 (TP, 12 pcs.)
-  19.71.006 (DP, 12 pcs.)



Ukrasni okvir crni
Decorative frame black

Broj artikla / Article No.:

-  19.75.001 (1M, 24 pcs.)
-  19.75.002 (2M, 12 pcs.)
-  19.75.003 (3M, 12 pcs.)
-  19.75.004 (4M, 12 pcs.)
-  19.75.005 (TP, 12 pcs.)
-  19.75.006 (DP, 12 pcs.)

TP za trofaznu priključnicu
for three-pole socket-outlet

DP za dvostruku priključnicu
for double two-pole socket-outlet

kombo



MORE POSSIBILITIES,
MORE STYLE,
MORE ...





Kompletna ponuda za hotele više kategorije
Complete offer for Hotels of higher categories

Stepen zaštite: IP20
Protection level: IP20

Svi moduli proizvode se u 5 boja
All modules are produced in 5 colors

Sve sklopke proizvedene su za nazivnu struju 16 AX
All switches are manufactured for rated current of 16 AX

IEC 60884-1 priključnice / socket; IEC 60669-1 sklopke / switch



vijčana veza
connection with screws



jezgro od polikarbonata
polycarbonate body

 **Priključi se...**

Koja je Vaša kombinacija?

What is your combination?

Modularni program elektro galanterije nudi mogućnost da korisnik sam odabere kombinaciju modula od kojih svaki kontroliše određenu funkciju u niskonaponskoj elektro instalaciji, i da ih rasporedi po svojoj želji, a na mnogo manjem prostoru u odnosu na klasične programe.

Modularni program ima niz prednosti. Najočiglednija prednost jeste prostor koji zauzimaju modularne sklopke i priključnice, jer je mnogo manji nego kod standardnih programa. Pored toga, kod standardnih programa, u nizajuće ukrasne okvire uglavnom je moguće smestiti najviše pet proizvoda, dok se kod modularnog programa u ukrasni okvir može smestiti sedam modula. Montaža modularnih sklopki i priključnica brža je i jednostavnija nego kod klasičnih programa.

Modular program range offers to user possibility to choose a combination of modules, where each one controls a specific function in low voltage electrical installations, and to place them according to their wishes, on the much smaller space compared to conventional programs.

Modular program has a number of advantages. The most obvious advantage is the area occupied by the modular switches and sockets, because it is much smaller than standard programs. In addition, with standard programs, in multiple decorative frames mostly is possible to place a maximum five products, whereas in modular programs in the decorative frame is possible to place seven modules. Installation of modular switches and sockets is faster and easier compared with conventional program.

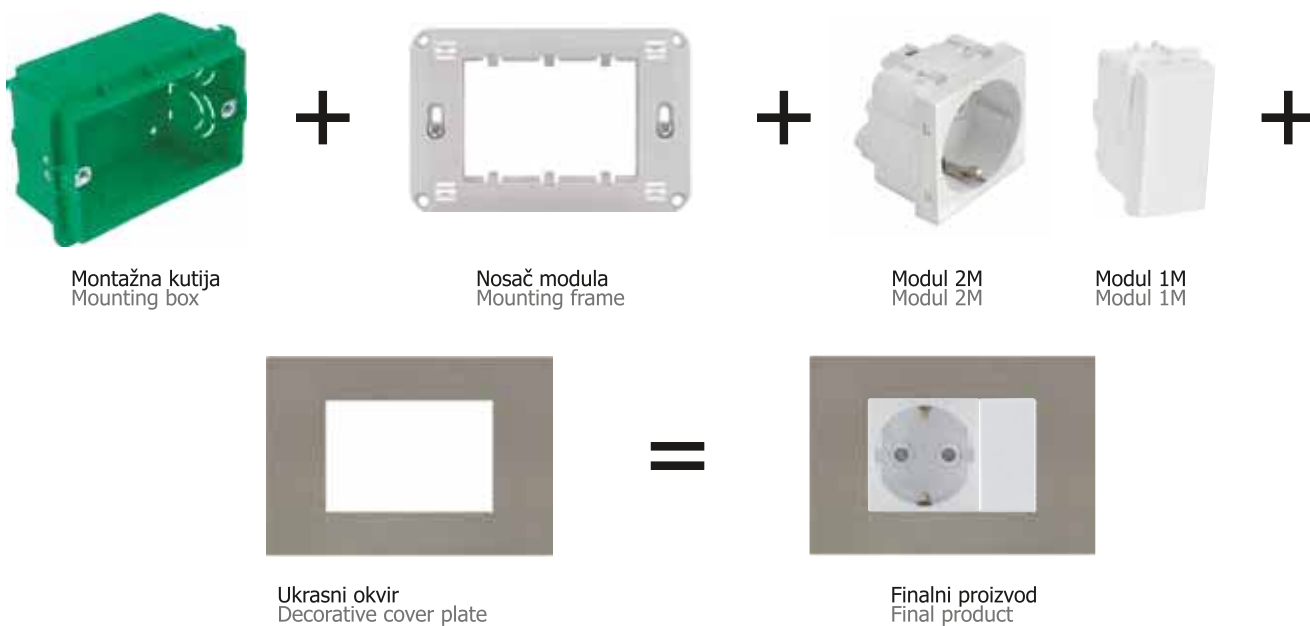

Montažna kutija (dozna) može biti za montažu u puni (klasični) ili šuplji (gips) zid. Za montažu jednog ili dva modula mogu se koristiti standardne montažne kutije (prečnika 60mm), koje se upotrebljavaju za montažu standardnih sklopki i priključnica.

Mounting box can be used for mounting in solid (classical) or cavity (gypsum) wall. For assembling of one or two modules can be used standard mounting boxes (diameter 60 mm), which are used for assembling of standard switches and sockets.



Montažne kutije za puni zid
Mounting boxes for solid walls



Montažna kutija za šuplji zid
Mounting boxes for cavity (gypsum) walls

Nosač modula služi kao podloga za montažu modula i ukrasnog okvira. Za montažnu kutiju (doznu) vezuje se pomoću vijaka (koji se isporučuju uz nosač modula) ili metalnih šapica (kod nosača modula za jedan i dva modula). Ukrasni okvir mora odgovarati broju modula za koji je montiran nosač modula. Montira se pritiskom na nosač modula, a jednostavno se skida ručnim odvijačem, pritiskom na zarez sa strane.

Mounting frame serves as a base for assembling of modules and decorative frame. For mounting box is connected with screws (provided with mounting frame) or metal claw (at mounting frame for 1 and 2 modules). Decorative frame must match to number of modules for which mounting frame is mounted. It's mounting by pressing on mounting frame, and can be easily removed with screwdriver, pressing on the side notches.

MODULES in colors



Tipkala za sklopke i tastere mogu biti širine 1M ili 2M, i dostupna su u belo, crnoj i zlatnoj boji. Pojedini moduli se mogu kupiti i bez tipkala, a ona se kupuju i montiraju naknadno. Tipkalo širine 2 modula ("2M") montira se ako je to estetski zahtev klijenta, ili ako u ukrasnom okviru postoji prazno mesto koje se na ovaj način maskira. Drugi način maskiranja praznog mesta u ukrasnom okviru jeste ugradnja praznog modula, koji zapravo predstavlja poklopac za nastalu prazninu. U slučaju potrebe klijent može zameniti samo tipkala i tako dobiti novi vizuelno drugačiji izgled priključnice.

Buttons for switches and push buttons can be 1M or 2M width and are available in white and black colour. Some modules can be purchased without buttons, which can be later bought and assembled. Button which is two modules width (2M) is assembled if that is an aesthetic client's request or if there is a blank place in decorative frame and is masked on this way. Another way of masking the empty place in decorative frame is to put an empty module, which actually represent a cover for the gap. If needed, the client can replace just buttons and get a new, visually different look, of switches and sockets.



Tipkalo 1M
Button 1M



Tipkalo 2M
Button 2M



Prazni modul 1M
Blank module 1M

U module sklopki i tastera sa signalnom sijalicom ugrađuje se (lakim ubacivanjem u za to predviđeni otvor) i tinjalica, a u ponudi je nekoliko boja, pa se i boja signalne sijalice može razlikovati za različite grupe potrošača. Prilikom montaže tinjalice važno je obratiti pažnju da se tinjalica montira ispod otvora za signalnu sijalicu.

In modules of switches and buttons with pilot light, lamp is installed (easy to insert into the provided holes), there are several colors to offer, so the color of signal lights may vary for different groups of consumers. When installing lamps it is important to pay attention that lamp is assembled below the hole for signal lights.

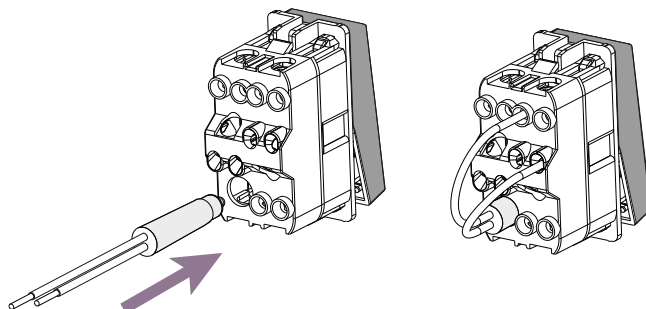



1M Sklopka jednopolna
1M Single pole switch
16AX/250V

- Broj artikla / Article No.:
- 21.01.621 (bela / white)
 - 21.19.621 (ivory / ivory)
 - 21.74.621 (srebrna/silver)
 - 21.71.621 (zlatna / gold)
 - 21.15.621 (crna / black)

Pakovanje / Pack:
20 kom / pcs.



1M Sklopka jednopolna sa indikacijom
1M Single pole switch diffuser
16AX/250V

- Broj artikla / Article No.:
- 21.01.627 (bela / white)
 - 21.19.627 (ivory / ivory)
 - 21.74.627 (srebrna/silver)
 - 21.71.627 (zlatna / gold)
 - 21.15.627 (crna / black)

Pakovanje / Pack:
20 kom / pcs.



1M Sklopka naizmenična
1M Two way switch
16AX/250V

- Broj artikla / Article No.:
- 21.01.625 (bela / white)
 - 21.19.625 (ivory / ivory)
 - 21.74.625 (srebrna/silver)
 - 21.71.625 (zlatna / gold)
 - 21.15.625 (crna / black)

Pakovanje / Pack:
20 kom / pcs.



1M Sklopka naizmenična sa indikacijom
1M Two way switch diffuser
16AX/250V

- Broj artikla / Article No.:
- 21.01.624 (bela / white)
 - 21.19.624 (ivory / ivory)
 - 21.74.624 (srebrna/silver)
 - 21.71.624 (zlatna / gold)
 - 21.15.624 (crna / black)

Pakovanje / Pack:
20 kom / pcs.



1M Sklopka unakrsna
1M Intermediate switch
16AX/250V

- Broj artikla / Article No.:
- 21.01.626 (bela / white)
 - 21.19.626 (ivory / ivory)
 - 21.74.626 (srebrna/silver)
 - 21.71.626 (zlatna / gold)
 - 21.15.626 (crna / black)

Pakovanje / Pack:
20 kom / pcs.



1M Sklopka dvopolna
1M Double pole switch
16AX/250V

- Broj artikla / Article No.:
- 21.01.622 (bela / white)
 - 21.19.622 (ivory / ivory)
 - 21.74.622 (srebrna/silver)
 - 21.71.622 (zlatna / gold)
 - 21.15.622 (crna / black)

Pakovanje / Pack:
20 kom / pcs.



1M Sklopka dvopolna naizmenična
1M Two way double pole switch
16AX/250V

- Broj artikla / Article No.:
- 21.01.628 (bela / white)
 - 21.19.628 (ivory / ivory)
 - 21.74.628 (srebrna/silver)
 - 21.71.628 (zlatna / gold)
 - 21.15.628 (crna / black)

Pakovanje / Pack:
20 kom / pcs.



1M Sklopka dvopolna sa indikacijom
1M Double pole switch diffuser
16AX/250V

- Broj artikla / Article No.:
- 21.01.623 (bela / white)
 - 21.19.623 (ivory / ivory)
 - 21.74.623 (srebrna/silver)
 - 21.71.623 (zlatna / gold)
 - 21.15.623 (crna / black)

Pakovanje / Pack:
20 kom / pcs.



1M Taster svetla sa indikacijom
1M Light push button diffuser
16A/250V

- Broj artikla / Article No.:
- 21.01.633 (bela / white)
 - 21.19.633 (ivory / ivory)
 - 21.74.633 (srebrna/silver)
 - 21.71.633 (zlatna / gold)
 - 21.15.633 (crna / black)

Pakovanje / Pack:
20 kom / pcs.



1M Taster zvona sa indikacijom
1M Bell push button diffuser
16A/250V

- Broj artikla / Article No.:
- 21.01.632 (bela / white)
 - 21.19.632 (ivory / ivory)
 - 21.74.632 (srebrna/silver)
 - 21.71.632 (zlatna / gold)
 - 21.15.632 (crna / black)

Pakovanje / Pack:
20 kom / pcs.



1M Potezni taster SOS sa indikacijom
1M SOS push button cord operated
16A/250V

- Broj artikla / Article No.:
- 21.01.620 (bela / white)
 - 21.19.620 (ivory / ivory)
 - 21.74.620 (srebrna/silver)
 - 21.71.620 (zlatna / gold)
 - 21.15.620 (crna / black)

Pakovanje / Pack:
20 kom / pcs.



1M Taster SOS sa indikacijom
1M SOS push button diffuser
16A/250V

- Broj artikla / Article No.:
- 21.01.635 (bela / white)
 - 21.19.635 (ivory / ivory)
 - 21.74.635 (srebrna/silver)
 - 21.71.635 (zlatna / gold)
 - 21.15.635 (crna / black)

Pakovanje / Pack:
20 kom / pcs.



1M Taster za roletne
1M Blind control button
16A/250V

- Broj artikla / Article No.:
- 21.01.021 (bela / white)
 - 21.19.021 (ivory / ivory)
 - 21.74.021 (srebrna/silver)
 - 21.71.021 (zlatna / gold)
 - 21.15.021 (crna / black)

Pakovanje / Pack:
20 kom / pcs.



1M Regulator svetla sa potencijetrom
1M Dimmer switch with potentiometer

Broj artikla / Article No.:

- | halogen bulbs
60-300W,230V | halogen bulbs
100-300W,230V,CE | LED
3-250W,230V |
|------------------------------------|------------------------------------|------------------------------------|
| <input type="checkbox"/> 21.01.242 | <input type="checkbox"/> 21.01.342 | <input type="checkbox"/> 21.01.442 |
| <input type="checkbox"/> 21.19.242 | <input type="checkbox"/> 21.19.342 | <input type="checkbox"/> 21.19.442 |
| <input type="checkbox"/> 21.74.242 | <input type="checkbox"/> 21.74.342 | <input type="checkbox"/> 21.74.442 |
| <input type="checkbox"/> 21.71.242 | <input type="checkbox"/> 21.71.342 | <input type="checkbox"/> 21.71.442 |
| <input type="checkbox"/> 21.15.242 | <input type="checkbox"/> 21.15.342 | <input type="checkbox"/> 21.15.442 |

Pakovanje / Pack:
10 kom / pcs.



2M Regulator svetla sa potencijetrom
2M Dimmer switch with potentiometer

Broj artikla / Article No.:

- | halogen bulbs
60-800W,230V | halogen bulbs
100-500W,230V,CE | LED
3-250W,230V |
|------------------------------------|------------------------------------|------------------------------------|
| <input type="checkbox"/> 22.01.242 | <input type="checkbox"/> 22.01.342 | <input type="checkbox"/> 22.01.442 |
| <input type="checkbox"/> 22.19.242 | <input type="checkbox"/> 22.19.342 | <input type="checkbox"/> 22.19.442 |
| <input type="checkbox"/> 22.74.242 | <input type="checkbox"/> 22.74.342 | <input type="checkbox"/> 22.74.442 |
| <input type="checkbox"/> 22.71.242 | <input type="checkbox"/> 22.71.342 | <input type="checkbox"/> 22.71.442 |
| <input type="checkbox"/> 22.15.242 | <input type="checkbox"/> 22.15.342 | <input type="checkbox"/> 22.15.442 |

Pakovanje / Pack:
10 kom / pcs.



1M Sklopka jedнопolna bez tipkala
1M Single pole switch without button
16AX/250V

Broj artikla / Article No.:
21.00.721

Pakovanje / Pack:
20 kom / pcs.



1M Sklopka naizmenična bez tipkala
1M Two way switch without button
16AX/250V

Broj artikla / Article No.:
21.00.725

Pakovanje / Pack:
20 kom / pcs.



1M Sklopka unakrsna bez tipkala
1M Intermediate switch without button
16AX/250V

Broj artikla / Article No.:
21.00.726

Pakovanje / Pack:
20 kom / pcs.



1M Sklopka dvopolna bez tipkala
1M Double pole switch without button
16AX/250V

Broj artikla / Article No.:
21.00.722

Pakovanje / Pack:
20 kom / pcs.



1M Taster jedнопolni bez tipkala
1M Single pole push button without button
16A/250V

Broj artikla / Article No.:
21.00.730

Pakovanje / Pack:
20 kom / pcs.



1M Sklopka jedнопolna bez tipkala za kupatilo (sa nulom)
1M Single pole switch without button with zero contact
16AX/250V

Broj artikla / Article No.:
21.00.746

Pakovanje / Pack:
20 kom / pcs.



2M Dvopolna priključnica
2M 2P+E schuko socket
16A/250V

- Broj artikla / Article No.:
- 22.01.051 (bela / white)
 - 22.19.051 (ivory / ivory)
 - 22.74.051 (srebrna/silver)
 - 22.71.051 (zlatna / gold)
 - 22.15.051 (crna / black)

Pakovanje / Pack:
20 kom / pcs.



2M Dvopolna priključnica sa zaštitom
2M 2P+E schuko socket shuttered
16A/250V

- Broj artikla / Article No.:
- 22.01.052 (bela / white)
 - 22.19.052 (ivory / ivory)
 - 22.74.052 (srebrna/silver)
 - 22.71.052 (zlatna / gold)
 - 22.15.052 (crna / black)

Pakovanje / Pack:
20 kom / pcs.



**2M Dvopolna priključnica
2P+E sa zaštitom**
2M 2P+E socket shuttered
16A/250V
(Francuski standard/French standard)

- Broj artikla / Article No.:
- 22.01.061 (bela / white)
 - 22.19.061 (ivory / ivory)
 - 22.74.061 (srebrna/silver)
 - 22.71.061 (zlatna / gold)
 - 22.15.061 (crna / black)

Pakovanje / Pack:
20 kom / pcs.



**2M Dvopolna priključnica
2P+E sa zaštitom**
2M 2P+E socket shuttered
16A/250V
(Francuski standard/French standard)

- Broj artikla / Article No.:
- 22.12.061
(crvena / red)

Pakovanje / Pack:
20 kom / pcs.



**2M Dvopolna priključnica
2P+E sa zaštitom**
2M 2P+E socket shuttered
16A/250V
(Francuski standard/French standard)

- Broj artikla / Article No.:
- 22.14.061
(zelena / green)

Pakovanje / Pack:
20 kom / pcs.



**2M Dvopolna priključnica
2P+E sa zaštitom**
2M 2P+E socket shuttered
16A/250V
(Francuski standard/French standard)

- Broj artikla / Article No.:
- 22.04.061
(narandžasta / orange)

Pakovanje / Pack:
20 kom / pcs.



**2M Dvopolna priključnica
sa zaštitom i poklopcem**
2M 2P+E schuko socket
shuttered, with cover
16A/250V

- Broj artikla / Article No.:
- 22.01.054 (bela / white)
 - 22.19.054 (ivory / ivory)
 - 22.74.054 (srebrna/silver)
 - 22.71.054 (zlatna / gold)
 - 22.15.054 (crna / black)

Pakovanje / Pack:
20 kom / pcs.



**2M Dvopolna priključnica
2P+E sa zaštitom i poklopcem**
2M 2P+E socket shuttered,
with cover
16A/250V; (French standard)

- Broj artikla / Article No.:
- 22.01.067 (bela / white)
 - 22.19.067 (ivory / ivory)
 - 22.74.067 (srebrna/silver)
 - 22.71.067 (zlatna / gold)
 - 22.15.067 (crna / black)

Pakovanje / Pack:
20 kom / pcs.



**2M Dvopolna priključnica
sa poklopcem**
2M 2P+E schuko socket,
with cover
16A/250V

- Broj artikla / Article No.:
- 22.01.064 (bela / white)
 - 22.19.064 (ivory / ivory)
 - 22.74.064 (srebrna/silver)
 - 22.71.064 (zlatna / gold)
 - 22.15.064 (crna / black)

Pakovanje / Pack:
20 kom / pcs.



**1M Dvopolna priključnica
2P sa zaštitom**
1M 2P socket shuttered
10A/250V
(italian standard, P10; 2P euro)

- Broj artikla / Article No.:
- 21.01.063 (bela / white)
 - 21.19.063 (ivory / ivory)
 - 21.74.063 (srebrna/silver)
 - 21.71.063 (zlatna / gold)
 - 21.15.063 (crna / black)
 - 21.12.063 (crvena / red)

Pakovanje / Pack:
20 kom / pcs.



**1M Dvopolna priključnica
2P+E sa zaštitom**
1M 2P+E socket shuttered
10A/250V
(italian standard, P11)

- Broj artikla / Article No.:
- 21.01.064 (bela / white)
 - 21.19.064 (ivory / ivory)
 - 21.74.064 (srebrna/silver)
 - 21.71.064 (zlatna / gold)
 - 21.15.064 (crna / black)

Pakovanje / Pack:
20 kom / pcs.



**1M Dvopolna priključnica
2P+E sa zaštitom**
1M 2P+E socket shuttered
16A/250V
(italian standard, P17/11)

- Broj artikla / Article No.:
- 21.01.060 (bela / white)
 - 21.19.060 (ivory / ivory)
 - 21.74.060 (srebrna/silver)
 - 21.71.060 (zlatna / gold)
 - 21.15.060 (crna / black)

Pakovanje / Pack:
20 kom / pcs.



**1M Dvopolna priključnica
2P+E sa zaštitom**
1M 2P+E socket shuttered
20A/250V
(italian standard, P17/11)

- Broj artikla / Article No.:
- 21.01.065 (bela / white)
 - 21.19.065 (ivory / ivory)
 - 21.74.065 (srebrna/silver)
 - 21.71.065 (zlatna / gold)
 - 21.15.065 (crna / black)

Pakovanje / Pack:
20 kom / pcs.



Tinjalica
Lamp

- Broj artikla / Article No.:
- 20.01.901 (bela / white)
 - 20.12.901 (crvena / red)
 - 20.14.901 (zelena / green)
 - 20.13.901 (plava / blue)
 - 20.09.901 (žuta / yellow)

Pakovanje / Pack:
50 kom / pcs.



1M TV priključnica završna
1M TV socket, end-line

- Broj artikla / Article No.:
- 21.01.090 (bela / white)
 - 21.19.090 (ivory / ivory)
 - 21.74.090 (srebrna/silver)
 - 21.71.090 (zlatna / gold)
 - 21.15.090 (crna / black)

Pakovanje / Pack:
20 kom / pcs.



1M TV priključnica prolazna
1M TV socket, feed-through

- Broj artikla / Article No.:
- 21.01.088 (bela / white)
 - 21.19.088 (ivory / ivory)
 - 21.74.088 (srebrna/silver)
 - 21.71.088 (zlatna / gold)
 - 21.15.088 (crna / black)

Pakovanje / Pack:
20 kom / pcs.



1M TV priključnica završna PAL/F
1M TV socket, end-line PAL/F

- Broj artikla / Article No.:
- 21.01.091 (bela / white)
 - 21.19.091 (ivory / ivory)
 - 21.74.091 (srebrna/silver)
 - 21.71.091 (zlatna / gold)
 - 21.15.091 (crna / black)

Pakovanje / Pack:
25 kom / pcs.



1M SAT TV priključnica završna F/F
1M SAT TV socket, end-line F/F

- Broj artikla / Article No.:
- 21.01.092 (bela / white)
 - 21.19.092 (ivory / ivory)
 - 21.74.092 (srebrna/silver)
 - 21.71.092 (zlatna / gold)
 - 21.15.092 (crna / black)

Pakovanje / Pack:
25 kom / pcs.



1M Audio priključnica 2xRCA
1M Audio socket 2xRCA

- Broj artikla / Article No.:
- 21.01.095 (bela / white)
 - 21.19.095 (ivory / ivory)
 - 21.74.095 (srebrna/silver)
 - 21.71.095 (zlatna / gold)
 - 21.15.095 (crna / black)

Pakovanje / Pack:
20 kom / pcs.



1M Telefonska priključnica RJ 12 6/4 623K
1M Telephone socket RJ12 6/4 623K

- Broj artikla / Article No.:
- 21.01.075 (bela / white)
 - 21.19.075 (ivory / ivory)
 - 21.74.075 (srebrna/silver)
 - 21.71.075 (zlatna / gold)
 - 21.15.075 (crna / black)

Pakovanje / Pack:
25 kom / pcs.



1M Komunikaciona priključnica RJ45 8/8 Cat6 UTP
1M Communication socket RJ45 8/8 Cat6 UTP

- Broj artikla / Article No.:
- 21.01.077 (bela / white)
 - 21.19.077 (ivory / ivory)
 - 21.74.077 (srebrna/silver)
 - 21.71.077 (zlatna / gold)
 - 21.15.077 (crna / black)

Pakovanje / Pack:
20 kom / pcs.



1M Komunikaciona priključnica RJ45 8/8 Cat6 STP
1M Communication socket RJ45 8/8 Cat6 STP

- Broj artikla / Article No.:
- 21.01.277 (bela / white)
 - 21.19.277 (ivory / ivory)
 - 21.74.277 (srebrna/silver)
 - 21.71.277 (zlatna / gold)
 - 21.15.277 (crna / black)

Pakovanje / Pack:
20 kom / pcs.



1M Prazni modul
1M Blanc module

- Broj artikla / Article No.:
- 21.01.900 (bela / white)
 - 21.19.900 (ivory / ivory)
 - 21.74.900 (srebrna/silver)
 - 21.71.900 (zlatna / gold)
 - 21.15.900 (crna / black)

Pakovanje / Pack:
30 kom / pcs.

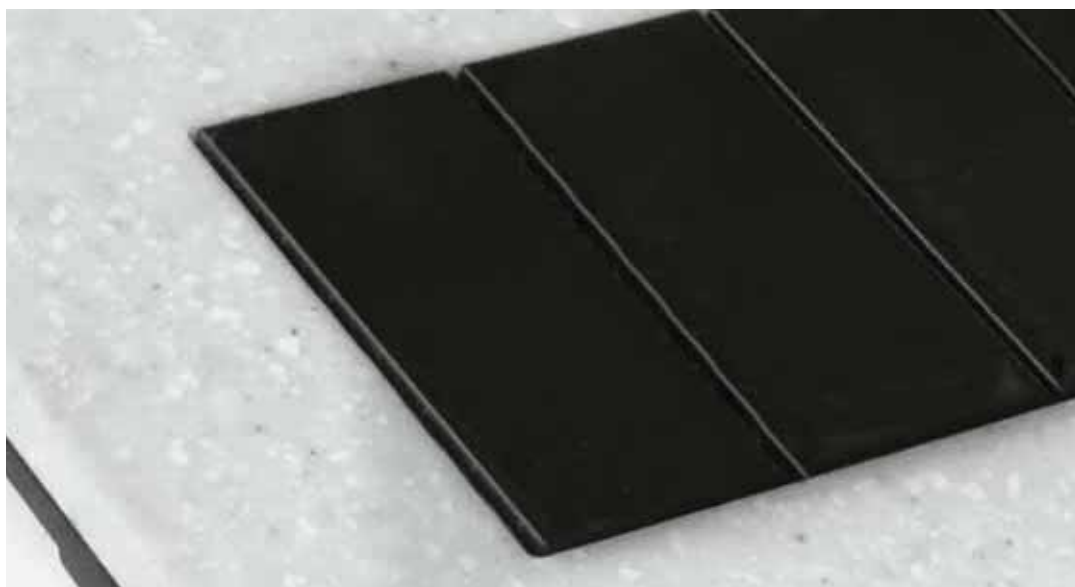



1M Tipkalo bez oznake
1M Button

- Broj artikla / Article No.:
- 21.01.921 (bela / white)
 - 21.19.921 (ivory / ivory)
 - 21.74.921 (srebrna/silver)
 - 21.71.921 (zlatna / gold)
 - 21.15.921 (crna / black)

Pakovanje / Pack:
50 kom / pcs.

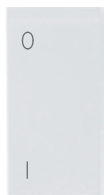

1M Tipkalo sa oznakom O/I
1M Button O/I

- Broj artikla / Article No.:
- 21.01.922 (bela / white)
 - 21.19.922 (ivory / ivory)
 - 21.74.922 (srebrna/silver)
 - 21.71.922 (zlatna / gold)
 - 21.15.922 (crna / black)

Pakovanje / Pack:
50 kom / pcs.



1M Tipkalo sa indikacijom
1M Button diffuser

- Broj artikla / Article No.:
- 21.01.927 (bela / white)
 - 21.19.927 (ivory / ivory)
 - 21.74.927 (srebrna/silver)
 - 21.71.927 (zlatna / gold)
 - 21.15.927 (crna / black)

Pakovanje / Pack:
50 kom / pcs.



1M Tipkalo sa indikacijom i oznakom za svetlo
1M Button diffuser – light

- Broj artikla / Article No.:
- 21.01.933 (bela / white)
 - 21.19.933 (ivory / ivory)
 - 21.74.933 (srebrna/silver)
 - 21.71.933 (zlatna / gold)
 - 21.15.933 (crna / black)

Pakovanje / Pack:
50 kom / pcs.



1M Tipkalo sa indikacijom i oznakom za zvono
1M Button diffuser – bell

- Broj artikla / Article No.:
- 21.01.932 (bela / white)
 - 21.19.932 (ivory / ivory)
 - 21.74.932 (srebrna/silver)
 - 21.71.932 (zlatna / gold)
 - 21.15.932 (crna / black)

Pakovanje / Pack:
50 kom / pcs.



1M Tipkalo sa indikacijom i oznakom za ventilator
1M Button diffuser – fan

- Broj artikla / Article No.:
- 21.01.992 (bela / white)
 - 21.19.992 (ivory / ivory)
 - 21.74.992 (srebrna/silver)
 - 21.71.992 (zlatna / gold)
 - 21.15.992 (crna / black)

Pakovanje / Pack:
50 kom / pcs.



1M Tipkalo sa indikacijom i oznakom za grejalicu
1M Button diffuser – stove

- Broj artikla / Article No.:
- 21.01.993 (bela / white)
 - 21.19.993 (ivory / ivory)
 - 21.74.993 (srebrna/silver)
 - 21.71.993 (zlatna / gold)
 - 21.15.993 (crna / black)

Pakovanje / Pack:
50 kom / pcs.



1M Tipkalo sa indikacijom i oznakom za veš mašinu
1M Button diffuser – washing machine

- Broj artikla / Article No.:
- 21.01.996 (bela / white)
 - 21.19.996 (ivory / ivory)
 - 21.74.996 (srebrna/silver)
 - 21.71.996 (zlatna / gold)
 - 21.15.996 (crna / black)

Pakovanje / Pack:
50 kom / pcs.



1M Tipkalo sa indikacijom i oznakom za bojler
1M Button diffuser – boiler

- Broj artikla / Article No.:
- 21.01.991 (bela / white)
 - 21.19.991 (ivory / ivory)
 - 21.74.991 (srebrna/silver)
 - 21.71.991 (zlatna / gold)
 - 21.15.991 (crna / black)

Pakovanje / Pack:
50 kom / pcs.



1M Tipkalo sa oznakom za ključ
1M Button diffuser – key

- Broj artikla / Article No.:
- 21.01.994 (bela / white)
 - 21.19.994 (ivory / ivory)
 - 21.74.994 (srebrna/silver)
 - 21.71.994 (zlatna / gold)
 - 21.15.994 (crna / black)

Pakovanje / Pack:
50 kom / pcs.

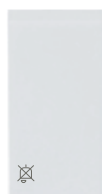

1M Tipkalo sa oznakom "Ne uznemiravaj"
1M Button "Do not disturb"

- Broj artikla / Article No.:
- 21.01.971 (bela / white)
 - 21.19.971 (ivory / ivory)
 - 21.74.971 (srebrna/silver)
 - 21.71.971 (zlatna / gold)
 - 21.15.971 (crna / black)

Pakovanje / Pack:
50 kom / pcs.



1M Tipkalo sa oznakom "Spremite sobu"
1M Button "Clean the room"

- Broj artikla / Article No.:
- 21.01.972 (bela / white)
 - 21.19.972 (ivory / ivory)
 - 21.74.972 (srebrna/silver)
 - 21.71.972 (zlatna / gold)
 - 21.15.972 (crna / black)

Pakovanje / Pack:
50 kom / pcs.



2M Tipkalo bez oznake
2M Button

- Broj artikla / Article No.:
- 22.01.921 (bela / white)
 - 22.19.921 (ivory / ivory)
 - 22.74.921 (srebrna/silver)
 - 22.71.921 (zlatna / gold)
 - 22.15.921 (crna / black)

Pakovanje / Pack:
35 kom / pcs.



2M Tipkalo sa oznakom O/I
2M Button O/I

- Broj artikla / Article No.:
- 22.01.922 (bela / white)
 - 22.19.922 (ivory / ivory)
 - 22.74.922 (srebrna/silver)
 - 22.71.922 (zlatna / gold)
 - 22.15.922 (crna / black)

Pakovanje / Pack:
35 kom / pcs.



2M Tipkalo sa indikacijom
2M Button diffuser

- Broj artikla / Article No.:
- 22.01.927 (bela / white)
 - 22.19.927 (ivory / ivory)
 - 22.74.927 (srebrna/silver)
 - 22.71.927 (zlatna / gold)
 - 22.15.927 (crna / black)

Pakovanje / Pack:
35 kom / pcs.



2M Tipkalo sa indikacijom i oznakom za svetlo
2M Button diffuser - light

- Broj artikla / Article No.:
- 22.01.933 (bela / white)
 - 22.19.933 (ivory / ivory)
 - 22.74.933 (srebrna/silver)
 - 22.71.933 (zlatna / gold)
 - 22.15.933 (crna / black)

Pakovanje / Pack:
35 kom / pcs.



2M Tipkalo sa indikacijom i oznakom za zvono
2M Button diffuser - bell

- Broj artikla / Article No.:
- 22.01.932 (bela / white)
 - 22.19.932 (ivory / ivory)
 - 22.74.932 (srebrna/silver)
 - 22.71.932 (zlatna / gold)
 - 22.15.932 (crna / black)

Pakovanje / Pack:
35 kom / pcs.



2M Tipkalo sa indikacijom i oznakom za bojler
2M Button diffuser - boiler

- Broj artikla / Article No.:
- 22.01.991 (bela / white)
 - 22.19.991 (ivory / ivory)
 - 22.74.991 (srebrna/silver)
 - 22.71.991 (zlatna / gold)
 - 22.15.991 (crna / black)

Pakovanje / Pack:
35 kom / pcs.

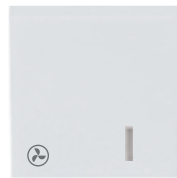

2M Tipkalo sa indikacijom i oznakom za ventilator
2M Button diffuser - fan

- Broj artikla / Article No.:
- 22.01.992 (bela / white)
 - 22.19.992 (ivory / ivory)
 - 22.74.992 (srebrna/silver)
 - 22.71.992 (zlatna / gold)
 - 22.15.992 (crna / black)

Pakovanje / Pack:
35 kom / pcs.



2M Tipkalo sa indikacijom i oznakom za grejalicu
2M Button diffuser - stove

- Broj artikla / Article No.:
- 22.01.993 (bela / white)
 - 22.19.993 (ivory / ivory)
 - 22.74.993 (srebrna/silver)
 - 22.71.993 (zlatna / gold)
 - 22.15.993 (crna / black)

Pakovanje / Pack:
35 kom / pcs.



2M Tipkalo sa indikacijom i oznakom za veš mašinu
2M Button diffuser -washing machine

- Broj artikla / Article No.:
- 22.01.996 (bela / white)
 - 22.19.996 (ivory / ivory)
 - 22.74.996 (srebrna/silver)
 - 22.71.996 (zlatna / gold)
 - 22.15.996 (crna / black)

Pakovanje / Pack:
35 kom / pcs.



2M Tipkalo sa indikacijom i oznakom za ključ
2M Button diffuser - key

- Broj artikla / Article No.:
- 22.01.994 (bela / white)
 - 22.19.994 (ivory / ivory)
 - 22.74.994 (srebrna/silver)
 - 22.71.994 (zlatna / gold)
 - 22.15.994 (crna / black)

Pakovanje / Pack:
35 kom / pcs.

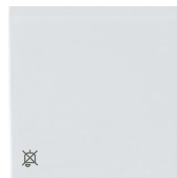

2M Tipkalo sa oznakom "Ne uznemiravaj"
2M Button "Do not disturb"

- Broj artikla / Article No.:
- 22.01.971 (bela / white)
 - 22.19.971 (ivory / ivory)
 - 22.74.971 (srebrna/silver)
 - 22.71.971 (zlatna / gold)
 - 22.15.971 (crna / black)

Pakovanje / Pack:
35 kom / pcs.



2M Tipkalo sa oznakom "Spremite sobu"
2M Button "Clean the room"

- Broj artikla / Article No.:
- 22.01.972 (bela / white)
 - 22.19.972 (ivory / ivory)
 - 22.74.972 (srebrna/silver)
 - 22.71.972 (zlatna / gold)
 - 22.15.972 (crna / black)

Pakovanje / Pack:
35 kom / pcs.

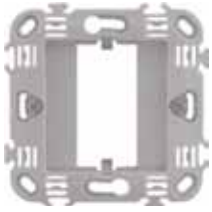

Nosač modula 1M
Mounting frame 1M
(sa šapicama / with claws)

Broj artikla / Article No.:
20.01.101

Pakovanje / Pack:
30 kom / pcs.



Nosač modula 2M
Mounting frame 2M
(sa šapicama / with claws)

Broj artikla / Article No.:
20.01.102

Pakovanje / Pack:
30 kom / pcs.



Nosač modula 3M
Mounting frame 3M
(sa vijcima / with screws)

Broj artikla / Article No.:
20.01.103

Pakovanje / Pack:
20 kom / pcs.



Nosač modula 4M
Mounting frame 4M
(sa vijcima / with screws)

Broj artikla / Article No.:
20.01.104

Pakovanje / Pack:
20 kom / pcs.



Nosač modula 5M
Mounting frame 5M
(sa vijcima / with screws)

Broj artikla / Article No.:
20.01.105

Pakovanje / Pack:
15 kom / pcs.



Nosač modula 7M
Mounting frame 7M
(sa vijcima / with screws)

Broj artikla / Article No.:
20.01.107

Pakovanje / Pack:
10 kom / pcs.

Montaža nosača modula / Mounting of mounting frame

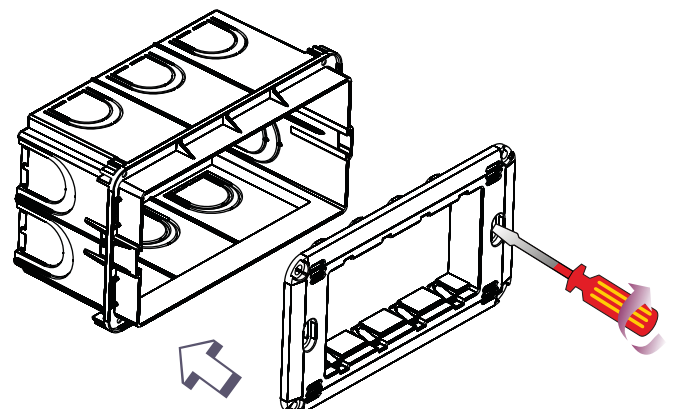
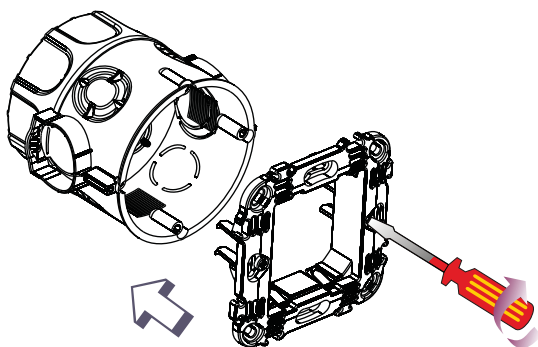



3M Montažna kutija PM3
3M Mounting box PM3
(za puni zid / for solid walls)

Broj artikla / Article No.:
20.00.003

Pakovanje / Pack:
5/165 kom / pcs.



4M Montažna kutija PM4
4M Mounting box PM4
(za puni zid / for solid walls)

Broj artikla / Article No.:
20.00.004

Pakovanje / Pack:
5/135 kom / pcs.



5M Montažna kutija PM5
5M Mounting box PM5
(za puni zid / for solid walls)

Broj artikla / Article No.:
20.00.005

Pakovanje / Pack:
5/110 kom / pcs.



7M Montažna kutija PM7
7M Mounting box PM7
(za puni zid / for solid walls)

Broj artikla / Article No.:
20.00.007

Pakovanje / Pack:
5/90 kom / pcs.



3M Montažna kutija VM3
3M Mounting box VM3
(za šuplji zid - gips /
for cavity (gypsum) walls)

Broj artikla / Article No.:
20.00.203

Pakovanje / Pack:
6/180 kom / pcs.



4M Montažna kutija VM4
4M Mounting box VM4
(za šuplji zid - gips /
for cavity (gypsum) walls)

Broj artikla / Article No.:
20.00.204

Pakovanje / Pack:
6/150 kom / pcs.



7M Montažna kutija VM7
7M Mounting box VM7
(za šuplji zid - gips /
for cavity (gypsum) walls)

Broj artikla / Article No.:
20.00.207

Pakovanje / Pack:
6/114 kom / pcs.



**Vezni element za
montažne kutije PM**
Distance element for
mounting boxes PM

Broj artikla / Article No.:
20.00.000

Pakovanje / Pack:
50/700 kom / pcs.

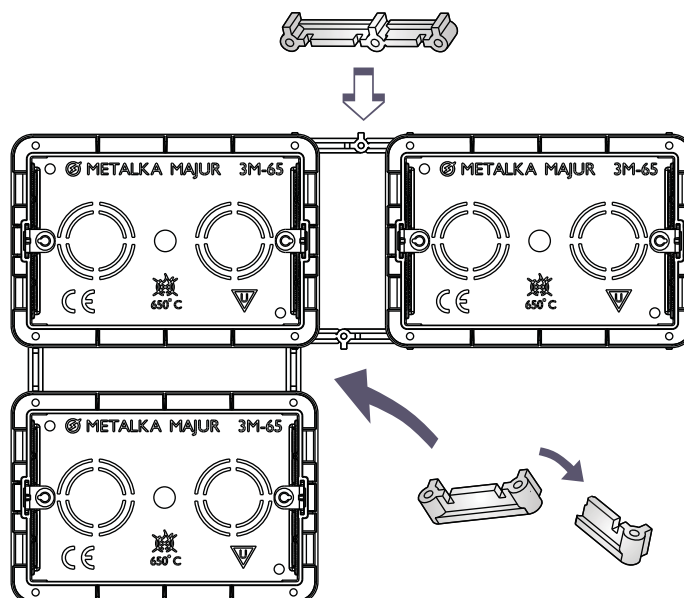

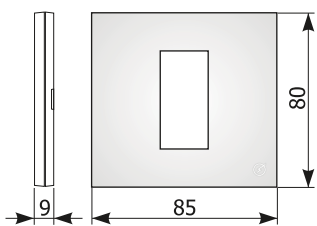

Ukrasni okvir 1M
Decorative cover plate 1M

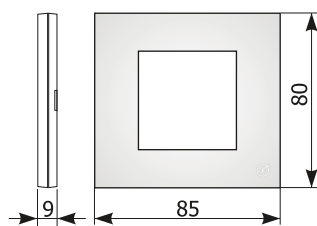

Ukrasni okvir 2M
Decorative cover plate 2M

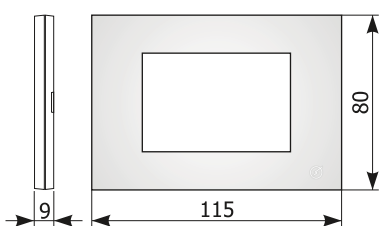

Ukrasni okvir 3M
Decorative cover plate 3M

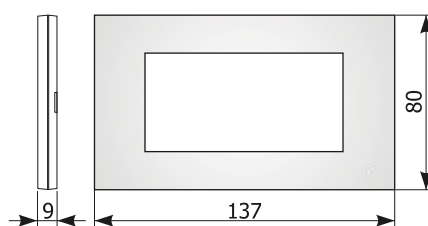

Ukrasni okvir 4M
Decorative cover plate 4M

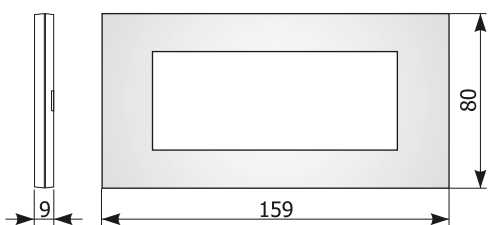

Ukrasni okvir 5M
Decorative cover plate 5M

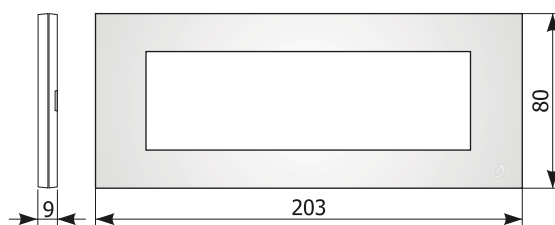





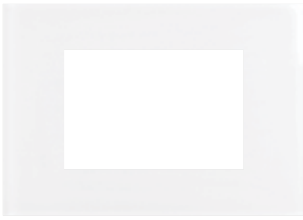

Ukrasni okvir 7M
Decorative cover plate 7M





Ukrasni okvir
Decorative cover plate
Beli / white







Broj artikla / Article No.:

-  20.01.001 (1M, 30 kom/pcs.)
-  20.01.002 (2M, 30 kom/pcs.)
-  20.01.003 (3M, 30 kom/pcs.)
-  20.01.004 (4M, 30 kom/pcs.)
-  20.01.005 (5M, 30 kom/pcs.)
-  20.01.007 (7M, 15 kom/pcs.)



Ukrasni okvir
Decorative cover plate
Slonova kost / ivory







Broj artikla / Article No.:

-  20.19.001 (1M, 30 kom/pcs.)
-  20.19.002 (2M, 30 kom/pcs.)
-  20.19.003 (3M, 30 kom/pcs.)
-  20.19.004 (4M, 30 kom/pcs.)
-  20.19.005 (5M, 30 kom/pcs.)
-  20.19.007 (7M, 15 kom/pcs.)



Ukrasni okvir
Decorative cover plate
Crni sjajni / black gloss







Broj artikla / Article No.:

-  20.15.001 (1M, 30 kom/pcs.)
-  20.15.002 (2M, 30 kom/pcs.)
-  20.15.003 (3M, 30 kom/pcs.)
-  20.15.004 (4M, 30 kom/pcs.)
-  20.15.005 (5M, 30 kom/pcs.)
-  20.15.007 (7M, 15 kom/pcs.)



Ukrasni okvir
Decorative cover plate
Zlatni / gold







Broj artikla / Article No.:

-  20.71.001 (1M, 30 kom/pcs.)
-  20.83.002 (2M, 30 kom/pcs.)
-  20.83.003 (3M, 30 kom/pcs.)
-  20.83.004 (4M, 30 kom/pcs.)
-  20.83.005 (5M, 30 kom/pcs.)
-  20.83.007 (7M, 15 kom/pcs.)



Ukrasni okvir
Decorative cover plate
Srebrni / silver





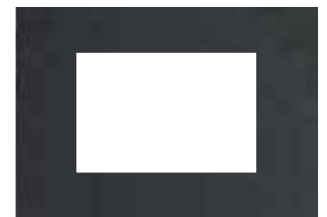

Broj artikla / Article No.:

-  20.74.001 (1M, 30 kom/pcs.)
-  20.85.002 (2M, 30 kom/pcs.)
-  20.85.003 (3M, 30 kom/pcs.)
-  20.85.004 (4M, 30 kom/pcs.)
-  20.85.005 (5M, 30 kom/pcs.)
-  20.85.007 (7M, 15 kom/pcs.)



Ukrasni okvir
Decorative cover plate
Crni mat / black glossless

Broj artikla / Article No.:

-  20.75.001 (1M, 30 kom/pcs.)
-  20.86.002 (2M, 30 kom/pcs.)
-  20.86.003 (3M, 30 kom/pcs.)
-  20.86.004 (4M, 30 kom/pcs.)
-  20.86.005 (5M, 30 kom/pcs.)
-  20.86.007 (7M, 15 kom/pcs.)

Svi artikli Kombo imaju atraktivno pojedinačno pakovanje.
All Kombo items have attractive individual packaging.





Za profesionalne korisnike obezbeđeno je grupno pakovanje, takozvani "profi pak" gde se 5 modula veličine 2M ili 10 modula veličine 1M pakuju u zajedničku kutiju, što profesionalnim instalaterima omogućava brži rad. Profi pak je dostupan za najprodavanije module sklopki i priključnica i ima nižu cenu od istog broja modula pakovanih u blister pakovanje.

Decorative frames are packed in small bags, while the group packaging, so called "profi pack" is available for professional users. This packaging can include 5 modules of size 2M, or 10 modules of size 1M, packed all together in small box, which makes work faster for professional installation workers. "Profi pack" is available for the most sold modules of switches and socket outlets, while its price is somewhat lower than the price of the same number of modules packed in blister packs.

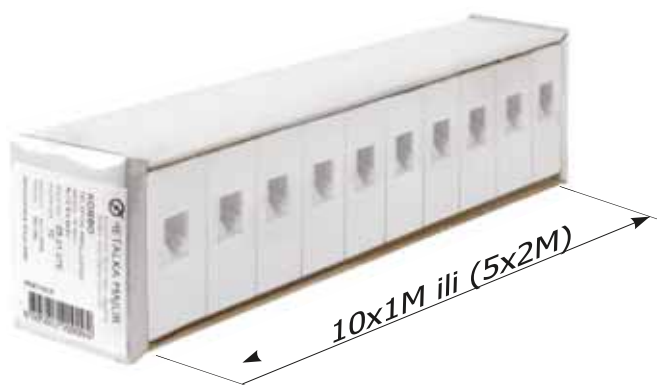

	Naziv	Item	Beli/white	Crni/black	Zlatni/gold	Srebrni/silver	Ivory/ivory	Pack
1	1M Sklopka jednopolna 16AX/250V, vijčana veza, 10/1	1M Single pole switch 16AX/250V, connection with screws, 10/1	25.01.621	25.15.621	25.71.621	25.74.621	25.19.621	10/1
2	1M Sklopka jednopolna 16AX/250V, sa indikacijom, vijčana veza, 10/1	1M Single pole switch diffuser 16AX/250V, connection with screws, 10/1	25.01.627	25.15.627	25.71.627	25.74.627	25.19.627	10/1
3	1M Sklopka naizmjenična 16AX/250V, vijčana veza, 10/1	1M Two way switch 16AX/250V, connection with screws, 10/1	25.01.625	25.15.625	25.71.625	25.74.625	25.19.625	10/1
4	1M Sklopka naizmjenična 16AX/250V, sa indikacijom, vijčana veza, 10/1	1M Two way switch diffuser 16AX/250V, connection with screws, 10/1	25.01.624	25.15.624	25.71.624	25.74.624	25.19.624	10/1
5	2M Dvopolna priključnica 16A/250V, sa kontaktom za uzemljenje, 5/1	2M 2P+E schuko socket 16A/250V, 5/1	25.01.051	25.15.051	25.71.051	25.74.051	25.19.051	5/1
6	1M Dvopolna priključnica sa zaštitom 10A/250V, bez kontakta za uzemljenje, 10/1	1M 2P socket shuttered 10A/250V, without earth contact, 10/1	25.01.063	25.15.063	25.71.063	25.74.063	25.19.063	10/1
7	1M TV priključnica - završna, 10/1	1M TV socket - end-line, 10/1	25.01.090	25.15.090	25.71.090	25.74.090	25.19.090	10/1
8	1M TV priključnica - završna PAL/F, 10/1	1M TV socket - end-line PAL/F, 10/1	25.01.091	25.15.091	25.71.091	25.74.091	25.19.091	10/1
9	1M Telefonska priključnica RJ12 6/4 623K, 10/1	1M Telephone socket RJ12 6/4 623K, 10/1	25.01.075	25.15.075	25.71.075	25.74.075	25.19.075	10/1
10	1M Komunikaciona priključnica RJ45 8/8 Cat 6 UTP, 10/1	1M Communication socket RJ45 8/8 Cat 6 UTP, 10/1	25.01.077	25.15.077	25.71.077	25.74.077	25.19.077	10/1
11	1M Komunikaciona priključnica RJ45 8/8 Cat 6 STP, 10/1	1M Communication socket RJ45 8/8 Cat 6 STP, 10/1	25.01.277	25.15.277	25.71.277	25.74.277	25.19.277	10/1
12	1M Prazan modul, 10/1	1M Blank module, 10/1	25.01.900	25.15.900	25.71.900	25.74.900	25.19.900	10/1

	Moduli bez tipkala	Modules without buttons					
1	1M Sklopka jednopolna 16AX/250V, bez tipkala, vijčana veza, 10/1	1M Single pole switch 16AX/250V, without button, connection with screws, 10/1	25.00.721	/	/	/	10/1
2	1M Sklopka naizmjenična 16AX/250V, bez tipkala, vijčana veza, 10/1	1M Two way switch 16AX/250V, without button, connection with screws, 10/1	25.00.725	/	/	/	10/1
3	1M Taster jednopolni 16A/250V, bez tipkala, vijčana veza, 10/1	1M Single pole push button 16A/250V, without button, 10/1	25.00.730	/	/	/	10/1

KOMBO 60

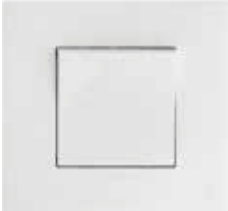

Sklopka jednopolna sa tipkalom 2M
2M Single pole switch with button
16AX/250V

Broj artikla / Article No.:
24.01.621

Pakovanje / Pack:
20 kom / pcs.



2M Dvostruka jednopolna sklopka
2M Double single pole switch
16AX/250V

Broj artikla / Article No.:
24.01.629

Pakovanje / Pack:
20 kom / pcs.

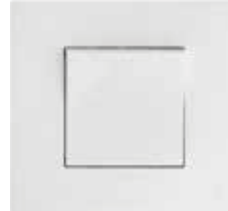

Sklopka naizmjenična sa tipkalom 2M
2M Two way switch with button
16AX/250V

Broj artikla / Article No.:
24.01.625

Pakovanje / Pack:
20 kom / pcs.



Dvopolna priključnica 2M
2M Two pole socket 2P+E
16A/250V

Broj artikla / Article No.:
24.01.051

Pakovanje / Pack:
20 kom / pcs.

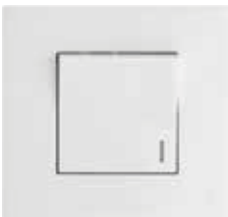

Sklopka za kupatilo sa tipkalom 2M
2M Bathroom switch with button
16AX/250V

Broj artikla / Article No.:
24.01.636

Pakovanje / Pack:
20 kom / pcs.



Sklopka za kupatilo 3M (svetlo, bojler, grejalica)
Bathroom switch 3M with indication for boiler, light and heater
16AX/250V

Broj artikla / Article No.:
24.01.096

Pakovanje / Pack:
8 kom / pcs.



Sklopka za kupatilo 4M (svetlo, bojler, grejalica, ventilator)
Bathroom switch 4M with indication for boiler, light, heater and ventilator
16AX/250V

Broj artikla / Article No.:
24.01.097

Pakovanje / Pack:
6 kom / pcs.



3M Univerzalni indikator za kupatilo sa LED indikacijom
3M Universal Bathroom switch with LED indication
16AX/250V

Broj artikla / Article No.:
21.01.695

Pakovanje / Pack:
9 kom / pcs.



ASSEMBLY INTO EXISTING MOUNTING BOXES OF ALL PRODUCER



KOMBO LED



MODULAR LED LIGHTING

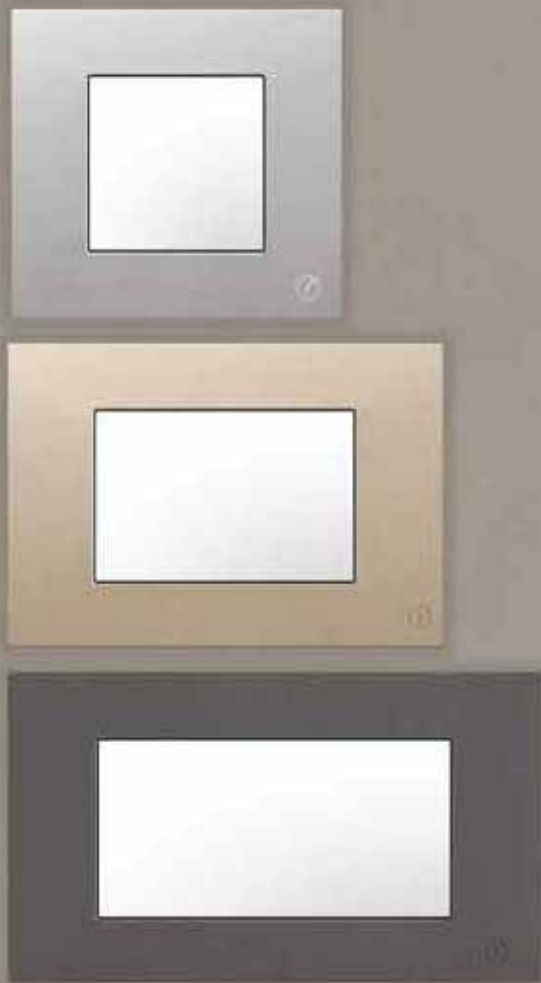

Kombo LED je moguće ugrađivati u parapetne razvode sa širinom otvora od 80mm.

Kombo LED can be built into the parapet trnking with the width of the opening of 80mm.





2M LED svetiljka
2M LED lighting

Broj artikla / Article No.:
 230V~ 21.01.102 (230V/50Hz)
 12V~ 21.01.202 (12V/50Hz)

Pakovanje / Pack:
20 kom / pcs.



3M LED svetiljka
3M LED lighting

Broj artikla / Article No.:
 230V~ 21.01.103 (230V/50Hz)
 12V~ 21.01.203 (12V/50Hz)

Pakovanje / Pack:
20 kom / pcs.



4M LED svetiljka
4M LED lighting

Broj artikla / Article No.:
 230V~ 21.01.104 (230V/50Hz)
 12V~ 21.01.204 (12V/50Hz)

Pakovanje / Pack:
20 kom / pcs.

KOMBO LED 2M

Tip
Standard
Ugao
Renderovani indeks
Boja svetla
Temperatura svetla
Snaga
Napon
Broj LED
LED izvor
Svetlosni fluks
Materijal
Radni vek

Type
Standard
Angle
Rendered index
Light colour
High temperature
Power
Voltage
Number of LEDs
LED light source
Luminous flux
Material
Lifetime

KOMBO LED/2M
EN 60598, CE
120°
80
Nature white
4000K
max 1W
230V/50Hz, 12V/50Hz
4
Samsung
72 lm
Polikarbonat
50.000h

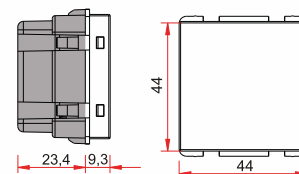

KOMBO LED 3M

Tip
Standard
Ugao
Renderovani indeks
Boja svetla
Temperatura svetla
Snaga
Napon
Broj LED
LED izvor
Svetlosni fluks
Materijal
Radni vek

Type
Standard
Angle
Rendered index
Light colour
High temperature
Power
Voltage
Number of LEDs
LED light source
Luminous flux
Material
Lifetime

KOMBO LED/3M
EN 60598, CE
120°
80
Nature white
4000K
max 1,5W
230V/50Hz, 12V/50Hz
6
Samsung
110 lm
Polikarbonat
50.000h

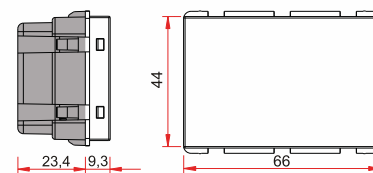

KOMBO LED 4M

Tip
Standard
Ugao
Renderovani indeks
Boja svetla
Temperatura svetla
Snaga
Napon
Broj LED
LED izvor
Svetlosni fluks
Materijal
Radni vek

Type
Standard
Angle
Rendered index
Light colour
High temperature
Power
Voltage
Number of LEDs
LED light source
Luminous flux
Material
Lifetime

KOMBO LED/4M
EN 60598, CE
120°
80
Nature white
4000K
max 2W
230V/50Hz, 12V/50Hz
8
Samsung
150 lm
Polikarbonat
50.000h

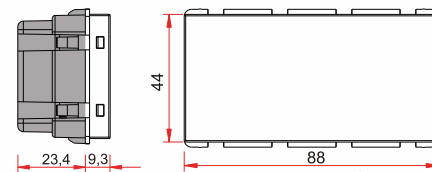

PREMIJER PLUS



RECOGNIZABLE
DESIGN OF
ROUNDED LINES ...





Lako se uklapa u različite tipove enterijera
Easily fits into different types of interior

Stepen zaštite: IP20
Protection level: IP20

Priključnice sa telom od keramike ili polikarbonata
Socket with ceramic or polycarbonate base

Sklopke sa vijčanim i bezvijčanim priključkom
Switches with screw and screwless connection

IEC 60884-1 priključnice / socket; IEC 60669-1 sklopke / switch



bv bezvijčana veza
screwless connection

jk jezgro od keramike
ceramic body

wv vijčana veza
connection with screws

jp jezgro od polikarbonata
polycarbonate body

 Prikluči se...



Jednopolna sklopka
Single-pole switch

10AX/250V; IP 20

Broj artikla / Article No.:

11.01.001 
11.01.021 

Pakovanje / Pack:
20 kom / pcs.



Jednopolna sklopka sa signalnom sijalicom
Single-pole switch with pilot light

10AX/250V; IP 20

Broj artikla / Article No.:

11.01.007 
11.01.027 

Pakovanje / Pack:
20 kom / pcs.

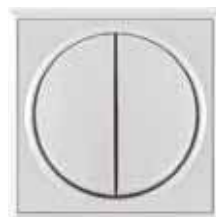

Serijska sklopka
Two-circuit switch

10AX/250V; IP 20

Broj artikla / Article No.:

11.01.004 
11.01.024 

Pakovanje / Pack:
20 kom / pcs.

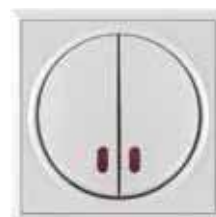

Serijska sklopka sa signalnim sijalicama
Two-circuit switch with pilot lights

10AX/250V; IP 20

Broj artikla / Article No.:

11.01.019 
11.01.039 

Pakovanje / Pack:
20 kom / pcs.



Naizmjenična sklopka
Two-way switch

10AX/250V; IP 20

Broj artikla / Article No.:

11.01.005 
11.01.025 

Pakovanje / Pack:
20 kom / pcs.



Unakrsna sklopka
Intermediate switch

10AX/250V; IP 20

Broj artikla / Article No.:

11.01.006 
11.01.026 



Pakovanje / Pack:
20 kom / pcs.



Dvopolna sklopka
Double-pole switch

10A/250V; IP 20

Broj artikla / Article No.:

11.01.002 
11.01.022 



Pakovanje / Pack:
20 kom / pcs.



Tropolna sklopka
Three-pole switch

10A/250V; IP 20

Broj artikla / Article No.:

11.01.003 
11.01.023 

Pakovanje / Pack:
20 kom / pcs.



Dvopolna naizmjenična sklopka

Two-way double-pole switch
10A/250V; IP 20

Broj artikla / Article No.:

11.01.008 
11.01.028 



Pakovanje / Pack:
20 kom / pcs.



Dvostruka naizmjenična sklopka

Double two-way switch
10A/250V; IP 20

Broj artikla / Article No.:

11.01.009 
11.01.029 

Pakovanje / Pack:
20 kom / pcs.



Taster svetla
Light push-button

10AX/250V; IP 20

Broj artikla / Article No.:

11.01.011 
11.01.031 

Pakovanje / Pack:
20 kom / pcs.



Taster svetla sa signalnom sijalicom
Light push-button with pilot light

10AX/250V; IP 20

Broj artikla / Article No.:

11.01.013 
11.01.033 

Pakovanje / Pack:
20 kom / pcs.



Taster zvona
Bell push-button
10AX/250V; IP 20

Broj artikla / Article No.:
11.01.010 **bv**
11.01.030 **wv**

Pakovanje / Pack:
20 kom / pcs.



Taster zvona sa signalnom sijalicom
Bell push-button with Pilot light
10AX/250V; IP 20

Broj artikla / Article No.:
11.01.012 **bv**
11.01.032 **wv**

Pakovanje / Pack:
20 kom / pcs.



Taster sa pločicom za natpis sa signalnom sijalicom
Push-button with illuminated label
10A/250V; IP 20

Broj artikla / Article No.:
11.01.017 **bv**
11.01.037 **wv**

Pakovanje / Pack:
20 kom / pcs.

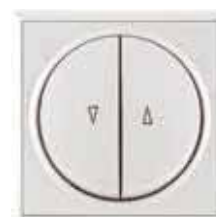

Taster za roletne
Blind control button
10A/250V; IP 20

Broj artikla / Article No.:
11.01.018 **bv**
11.01.038 **wv**

Pakovanje / Pack:
20 kom / pcs.



Taster SOS sa signalnom sijalicom
SOS push-button with pilot light
10A/250V; IP 20

Broj artikla / Article No.:
11.01.015 **bv**
11.01.035 **wv**

Pakovanje / Pack:
20 kom / pcs.



Potezni taster SOS
SOS push-button cord operated
10A/250V; IP 20

Broj artikla / Article No.:
11.01.020 **bv**
11.01.040 **wv**

Pakovanje / Pack:
20 kom / pcs.



Elektronski regulator svetlosti sa potenciometrom
Dimmer switch with potentiometer

Broj artikla:
11.01.242 (230V; 60-800W)
11.01.342 (230V; 100-500W,CE)
11.01.442 (230V; 3-250W, LED)

Pakovanje:
16 kom.



Jednopolna sklopka sa preklonikom i signalnom sijalicom
Single-pole switch with tumbler switch and pilot light
16AX/250V; IP 20

Broj artikla / Article No.:
11.01.045 **jk**

Pakovanje / Pack:
20 kom / pcs.



Dvopolna priključnica
Two-pole socket-outlet
16A/250V; IP 20

Broj artikla / Article No.:
11.01.050 **jk**
11.01.051 **jp**

Pakovanje / Pack:
20 kom / pcs.



Dvopolna priključnica sa zaštitnim elementom
Two-pole socket-outlet with protection
16A/250V; IP 20

Broj artikla / Article No.:
11.01.052 **jp**

Pakovanje / Pack:
20 kom / pcs.



Dvopolna priključnica sa zaštitnim elementom, crvena
Two-pole socket-outlet with protection, red
16A/250V; IP 20

Broj artikla / Article No.:
11.12.052 **jp**

Pakovanje / Pack:
20 kom / pcs.



Dvopolna priključnica sa zaštitnim elementom, zelena
Two-pole socket-outlet with protection, green
16A/250V; IP 20

Broj artikla / Article No.:
11.14.052 **jp**

Pakovanje / Pack:
20 kom / pcs.



Dvopolna priključnica sa zaštitnim elementom, narandžasta
Two-pole socket-outlet with protection, orange
16A/250V; IP 20

Broj artikla / Article No.:
11.04.052 

Pakovanje / Pack:
20 kom / pcs.



Dvopolna priključnica sa poklopcem
Two-pole socket-outlet with cover
16A/250V; IP 20

Broj artikla / Article No.:
11.01.058 
11.01.053 

Pakovanje / Pack:
20 kom / pcs.



Dvopolna priključnica sa poklopcem i zaštitnim elementom
Two-pole socket-outlet with cover and protection
16A/250V; IP 20

Broj artikla / Article No.:
11.01.054 

Pakovanje / Pack:
20 kom / pcs.



Trofazna priključnica
Three-pole socket-outlet
16A/440V; IP 20

Broj artikla / Article No.:
11.01.059 

Pakovanje / Pack:
16 kom / pcs.



Dvostruka priključnica sa zaštitnim elementom
Double two-pole socket-outlet with protection
16A/250V; IP 20

Broj artikla / Article No.:
11.01.056 

Pakovanje / Pack:
12 kom / pcs.



Dvostruka priključnica
Double two-pole socket-outlet
16A/250V; IP 20

Broj artikla / Article No.:
11.01.057 
11.01.055 

Pakovanje / Pack:
12 kom / pcs.



Telefonska priključnica RJ12 6/4 sa jednim modulom 623K
Telephone socket RJ12 6/4 with one module 623K
IP 20

Broj artikla / Article No.:
11.01.071

Pakovanje / Pack:
24 kom / pcs.



Telefonska priključnica RJ12 6/4 sa dva modula 623K
Telephone socket RJ12 6/4 with two modules 623K
IP 20

Broj artikla / Article No.:
11.01.072

Pakovanje / Pack:
24 kom / pcs.



Komunikaciona priključnica RJ45 8/8 sa jednim modulom Cat6 UTP
Communication socket Rj45 8/8 with one module Cat6 UTP
IP 20

Broj artikla / Article No.:
11.01.077

Pakovanje / Pack:
24 kom / pcs.



Komunikaciona priključnica RJ45 8/8 sa dva modula Cat6 UTP
Communication socket RJ45 8/8 with two modules Cat6 UTP
IP 20

Broj artikla / Article No.:
11.01.078

Pakovanje / Pack:
24 kom / pcs.



Komunikaciona priključnica RJ45 8/8 sa jednim modulom Cat6 STP
Communication socket RJ45 8/8 with one module Cat6 STP
IP 20

Broj artikla / Article No.:
11.01.277

Pakovanje / Pack:
24 kom / pcs.



Komunikaciona priključnica RJ45 8/8 sa dva modula Cat6 STP
Communication socket Rj45 8/8 with two modules Cat6 STP
IP 20

Broj artikla / Article No.:
11.01.278

Pakovanje / Pack:
24 kom / pcs.



TV priključnica sa jednim modulom
TV aerial socket with one module
IEC 169-2; CEI EN 50083-1, -2, -4;
IP 20

Broj artikla / Article No.:
11.01.088 (prolazna/feed through)
11.01.090 (završna/terminal)

Pakovanje / Pack:
24 kom / pcs.



TV priključnica sa dva modula
TV aerial socket with two modules
IEC 169-2; CEI EN 50083-1, -2, -4;
IP 20

Broj artikla / Article No.:
11.01.092 (prolazno-završna/feed through-terminal)
11.01.091 (završna/terminal)

Pakovanje / Pack:
24 kom / pcs.



Horizontalna sklopka za kupatilo
Horizontal bathroom switch
16AX/250V; IP 20

Broj artikla / Article No.:
11.01.095

Pakovanje / Pack:
7 kom / pcs.



Radio / TV / SAT priključnica sa elektronskim sklopom
Radio / TV / SAT aerial socket with electronic subassembly
IEC 169-2; CEI EN 50083-1, -2, -4;
IP 20

Broj artikla / Article No.:
11.01.084 (završna/terminal)

Pakovanje / Pack:
24 kom / pcs.



Vertikalna sklopka za kupatilo
Vertical bathroom switch
10AX/250V; 16AX/250V; IP 20

Broj artikla / Article No.:
11.01.096

Pakovanje / Pack:
7 kom / pcs.



Vertikalna sklopka za kupatilo sa serijskom sklopkom
Vertical bathroom switch with Two-circuit switch
10AX/250V; 16AX/250V; IP 20

Broj artikla / Article No.:
11.01.097

Pakovanje / Pack:
7 kom / pcs.



Vertikalna sklopka za kupatilo sa serijskom sklopkom i signalnim sijalicama
Vertical bathroom switch with two-circuit switch and pilot lights
10AX/250V; 16AX/250V; IP 20

Broj artikla / Article No.:
11.01.099

Pakovanje / Pack:
7 kom / pcs.



Vertikalna sklopka za kupatilo sa dvopolnom priključnicom
Vertical bathroom switch with two-pole socket-outlet
10AX/250V; 16AX/250V; Ip20

Broj artikla / Article No.:
11.01.098

Pakovanje / Pack:
7 kom / pcs.

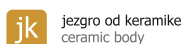



Dvopolna priključnica "F" tip (francuski standard)
Two-pole socket-outlet "F" type (French standard)
16A/250V; IP 20

Broj artikla / Article No.:
[jp](#) 01.061

Pakovanje / Pack:
20 kom / pcs.



Dvopolna priključnica sa zaštitnim elementom "F" tip (francuski standard)
Two-pole socket-outlet with protection "F" type (Fr. standard)
16A/250V; IP 20

Broj artikla / Article No.:
11.01.062 [jp](#)

Pakovanje / Pack:
20 kom / pcs.



Dvopolna priključnica sa poklopcem "F" tip (francuski standard)
Two-pole socket-outlet with cover "F" type (Fr. standard)
16A/250V; IP 20

Broj artikla / Article No.:
11.01.067 [jp](#)

Pakovanje / Pack:
20 kom / pcs.



Dvopolna priključnica sa poklopcem i zaštitnim elementom "F" tip (francuski standard)
Two-pole socket-outlet with cover and protection "F" type (French standard)
16A/250V; IP 20

Broj artikla / Article No.:
11.01.079 [jp](#)

Pakovanje / Pack:
20 kom / pcs.



Dvopolna priključnica bez kontakta za uzemljenje
Two-pole socket-outlet without earthing contact
16A/250V; IP 20

Broj artikla / Article No.:
11.01.151 [jp](#)

Pakovanje / Pack:
20 kom / pcs.



Dvopolna priključnica sa zaštitnim elementom, bez kontakta za uzemljenje
Two-pole socket-outlet with protection, without earthing contact
16A/250V; IP 20

Broj artikla / Article No.:
11.01.152 [jp](#)

Pakovanje / Pack:
20 kom / pcs.



Dvostruka priključnica sa zaštitnim elementom "F" tip (francuski standard)
Double two-pole socket-outlet with protection "F" type (French standard)
16A/250V; IP 20

Broj artikla / Article No.:
11.01.065 [jp](#)

Pakovanje / Pack:
12 kom / pcs.



Dvostruka priključnica sa zaštitnim elementom "F" tip (francuski standard)
Double two-pole socket-outlet with protection "F" type (French standard)
16A/250V; IP 20

Broj artikla / Article No.:
11.01.066 [jp](#)

Pakovanje / Pack:
12 kom / pcs.



Dvostruka priključnica bez kontakta za uzemljenje
Double two-pole socket-outlet without earthing contact
16A/250V; IP 20

Broj artikla / Article No.:
11.01.155 [jp](#)

Pakovanje / Pack:
12 kom / pcs.



Dvostruka priključnica sa zaštitnim elementom, bez kontakta za uzemljenje
Double two-pole socket-outlet with protection, without earthing contact
16A/250V; IP 20

Broj artikla / Article No.:
11.01.156 [jp](#)

Pakovanje / Pack:
12 kom / pcs.



**Petostruki ukrasni okvir -
horizontalni i vertikalni**
Five-set decorative frame
(horizontal and vertical)

Broj artikla / Article No.:
11.01.357

Pakovanje / Pack:
10 kom / pcs.



**Četvorostruki ukrasni okvir -
horizontalni i vertikalni**
Quadruple decorative frame
(horizontal and vertical)

Broj artikla / Article No.:
11.01.356

Pakovanje / Pack:
10 kom / pcs.



**Trostruki ukrasni okvir -
horizontalni i vertikalni**
Triple decorative frame
(horizontal and vertical)

Broj artikla / Article No.:
11.01.355

Pakovanje / Pack:
20 kom / pcs.



**Dvostruki ukrasni okvir -
horizontalni i vertikalni**
Double decorative frame
(horizontal and vertical)

Broj artikla / Article No.:
11.01.354

Pakovanje / Pack:
30 kom / pcs.

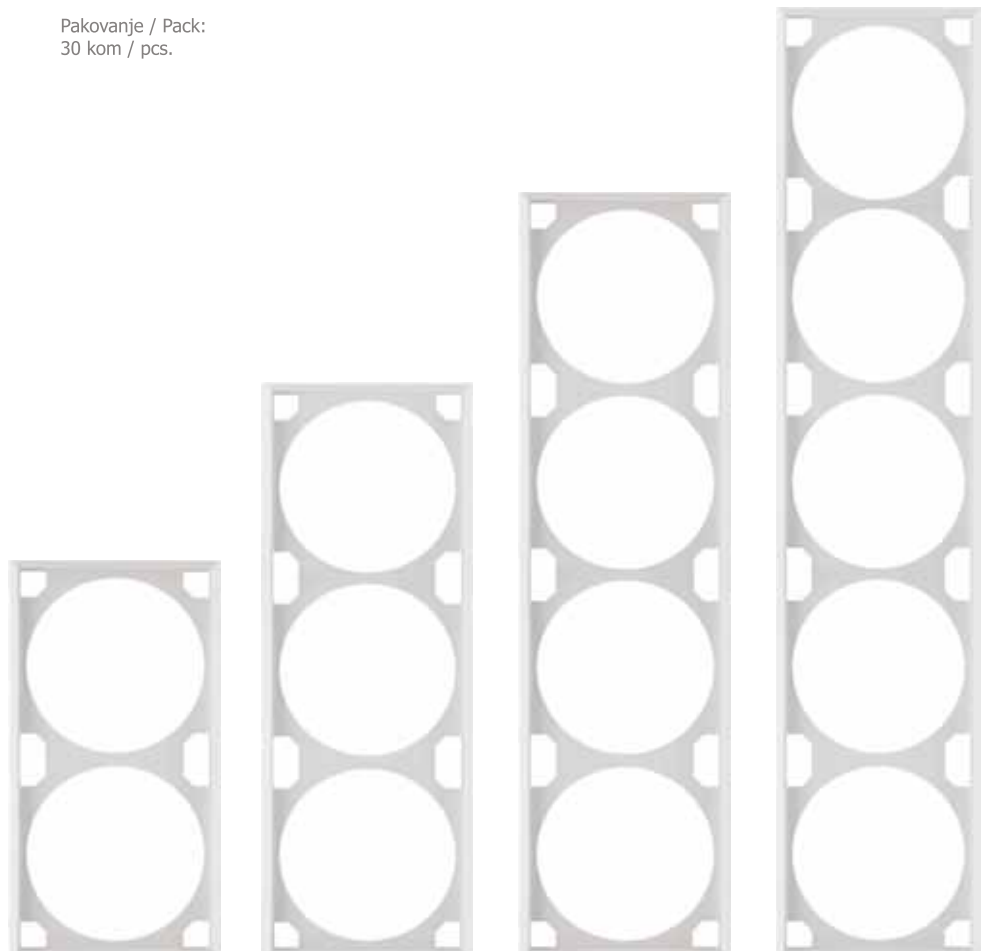

Status



RECOGNIZABLE
SHARP LINE
DESIGN ...





Jednostavna i brza montaža
Simple and fast assembly

Stepen zaštite: IP20
Protection level: IP20

Priključnice sa telom od keramike ili polikarbonata
Socket with ceramic or polycarbonate base

Sklopke sa vijčanim i bezvijčanim priključkom
Switches with screw and screwless connection

IEC 60884-1 priključnice / socket; IEC 60669-1 sklopke / switch



bv bezvijčana veza
screwless connection

jk jezgro od keramike
ceramic body

wv vijčana veza
connection with screws

jp jezgro od polikarbonata
polycarbonate body

 Prikluči se...



Jednopolna sklopka
Single-pole switch
10AX/250V; IP 20

Broj artikla / Article No.:
14.01.001 
14.01.021 

Pakovanje / Pack:
20 kom / pcs.



Jednopolna sklopka sa signalnom sijalicom
Single-pole switch with pilot light
10AX/250V; IP 20

Broj artikla / Article No.:
14.01.007 
14.01.027 

Pakovanje / Pack:
20 kom / pcs.



Serijska sklopka
Two-circuit switch
10AX/250V; IP 20

Broj artikla / Article No.:
14.01.004 
14.01.024 

Pakovanje / Pack:
20 kom / pcs.



Serijska sklopka sa signalnim sijalicama
Two-circuit switch with pilot lights
10AX/250V; IP 20

Broj artikla / Article No.:
14.01.019 
14.01.039 

Pakovanje / Pack:
20 kom / pcs.



Naizmjenična sklopka
Two-way switch
10AX/250V; IP 20

Broj artikla / Article No.:
14.01.005 
14.01.025 

Pakovanje / Pack:
20 kom / pcs.



Unakrsna sklopka
Intermediate switch
10AX/250V; IP 20

Broj artikla / Article No.:
14.01.006 
14.01.026 

Pakovanje / Pack:
20 kom / pcs.



Dvopolna sklopka
Double-pole switch
10A/250V; IP 20

Broj artikla / Article No.:
14.01.002 
14.01.022 

Pakovanje / Pack:
20 kom / pcs.



Tropolna sklopka
Three-pole switch
10A/250V; IP 20

Broj artikla / Article No.:
14.01.003 
14.01.023 

Pakovanje / Pack:
20 kom / pcs.



Dvopolna naizmjenična sklopka
Two-way double-pole switch
10A/250V; IP 20

Broj artikla / Article No.:
14.01.008 
14.01.028 

Pakovanje / Pack:
20 kom / pcs.



Dvostruka naizmjenična sklopka
Double two-way switch
10A/250V; IP 20

Broj artikla / Article No.:
14.01.009 
14.01.029 

Pakovanje / Pack:
20 kom / pcs.



Taster svetla
Light push-button
10AX/250V; IP 20

Broj artikla / Article No.:
14.01.011 
14.01.031 

Pakovanje / Pack:
20 kom / pcs.



Taster svetla sa signalnom sijalicom
Light push-button with pilot light
10AX/250V; IP 20

Broj artikla / Article No.:
14.01.013 
14.01.033 

Pakovanje / Pack:
20 kom / pcs.



Taster zvona
Bell push-button
10AX/250V; IP 20

Broj artikla / Article No.:
14.01.010 **bv**
14.01.030 **vv**

Pakovanje / Pack:
20 kom / pcs.



Taster zvona sa signalnom sijalicom
Bell push-button with Pilot light
10AX/250V; IP 20

Broj artikla / Article No.:
14.01.012 **bv**
14.01.032 **vv**

Pakovanje / Pack:
20 kom / pcs.



Taster sa pločicom za natpis sa signalnom sijalicom
Push-button with illuminated label
10A/250V; IP 20

Broj artikla / Article No.:
14.01.017 **bv**
14.01.037 **vv**

Pakovanje / Pack:
20 kom / pcs.



Taster za roletne
Blind control button
10A/250V; IP 20

Broj artikla / Article No.:
14.01.018 **bv**
14.01.038 **vv**

Pakovanje / Pack:
20 kom / pcs.



Taster SOS sa signalnom sijalicom
SOS push-button with pilot light
10A/250V; IP 20

Broj artikla / Article No.:
14.01.015 **bv**
14.01.035 **vv**

Pakovanje / Pack:
20 kom / pcs.



Potezni taster SOS
SOS push-button cord operated
10A/250V; IP 20

Broj artikla / Article No.:
14.01.020 **bv**
14.01.040 **vv**

Pakovanje / Pack:
20 kom / pcs.



Elektronski regulator svetlosti sa potencijetrom
Dimmer switch with potentiometer

Broj artikla:
14.01.242 (230V; 60-800W)
14.01.342 (230V; 100-500W,CE)
14.01.442 (230V; 3-250W, LED)

Pakovanje:
16 kom.



Jednopolna sklopka sa preklopnikom i signalnom sijalicom
Single-pole switch with tumbler switch and pilot light
16AX/250V; IP 20

Broj artikla / Article No.:
14.01.045 **jk**

Pakovanje / Pack:
20 kom / pcs.



Dvopolna priključnica
Two-pole socket-outlet
16A/250V; IP 20

Broj artikla / Article No.:
14.01.050 **jk**
14.01.051 **jp**
14.01.074 (ekonomik) **jp**

Pakovanje / Pack:
20 kom / pcs.



Dvopolna priključnica sa zaštitnim elementom
Two-pole socket-outlet with protection
16A/250V; IP 20

Broj artikla / Article No.:
14.01.052 **jp**

Pakovanje / Pack:
24 kom / pcs.



Dvopolna priključnica sa zaštitnim elementom, crvena
Two-pole socket-outlet with protection, red
16A/250V; IP 20

Broj artikla / Article No.:
14.12.052 **jp**

Pakovanje / Pack:
20 kom / pcs.



Dvopolna priključnica sa zaštitnim elementom, zelena
Two-pole socket-outlet with protection, green
16A/250V; IP 20

Broj artikla / Article No.:
14.14.052 **jp**

Pakovanje / Pack:
20 kom / pcs.



Dvopolna priključnica sa zaštitnim elementom, narandžasta
Two-pole socket-outlet with protection, orange
16A/250V; IP 20

Broj artikla / Article No.:
14.04.052 

Pakovanje / Pack:
20 kom / pcs.





Dvopolna priključnica sa poklopcem
Two-pole socket-outlet with cover
16A/250V; IP 20

Broj artikla / Article No.:
14.01.058 
14.01.053 

Pakovanje / Pack:
20 kom / pcs.



Dvopolna priključnica sa transparentnim poklopcem
Two-pole socket-outlet with transparent cover
16A/250V; IP 20

Broj artikla / Article No.:
14.01.068 
14.01.063 

Pakovanje / Pack:
20 kom / pcs.



Dvopolna priključnica sa poklopcem i zaštitnim elementom
Two-pole socket-outlet with cover and protection
16A/250V; IP 20

Broj artikla / Article No.:
14.01.054 

Pakovanje / Pack:
20 kom / pcs.



Dvopolna priključnica sa transparentnim poklopcem i zaštitnim elementom
Two-pole socket-outlet with transparent cover and protection
16A/250V; IP 20

Broj artikla / Article No.:
14.01.064 

Pakovanje / Pack:
20 kom / pcs.



Dvostruka priključnica
Double two-pole socket-outlet
16A/250V; IP 20

Broj artikla / Article No.:
14.01.057 
14.01.055 

Pakovanje / Pack:
12 kom / pcs.



Dvostruka priključnica sa zaštitnim elementom
Double two-pole socket-outlet with protection
16A/250V; IP 20

Broj artikla / Article No.:
14.01.056 

Pakovanje / Pack:
12 kom / pcs.



Trofazna priključnica
Three-pole socket-outlet
16A/440V; IP 20

Broj artikla / Article No.:
14.01.059 

Pakovanje / Pack:
16 kom / pcs.



Telefonska priključnica RJ12 6/4 sa jednim modulom 623K
Telephone socket RJ12 6/4 with one module 623K
IP 20

Broj artikla / Article No.:
14.01.071

Pakovanje / Pack:
24 kom / pcs.



Telefonska priključnica RJ12 6/4 sa dva modula 623K
Telephone socket RJ12 6/4 with two modules 623K
IP 20

Broj artikla / Article No.:
14.01.072

Pakovanje / Pack:
24 kom / pcs.



TV priključnica sa jednim modulom
TV aerial socket with one module
IEC 169-2; CEI EN 50083-1, -2, -4;
IP 20

Broj artikla / Article No.:
14.01.088 (prolazna/feed through)
14.01.090 (završna/terminal)

Pakovanje / Pack:
24 kom / pcs.



TV priključnica sa dva modula
TV aerial socket with two modules
IEC 169-2; CEI EN 50083-1, -2, -4;
IP 20

Broj artikla / Article No.:
14.01.092 (prolazno-završna/feed through-terminal)
14.01.091 (završna/terminal)

Pakovanje / Pack:
24 kom / pcs.



Komunikaciona priključnica RJ45 8/8 sa jednim modulom Cat6 STP

Communication socket RJ45 8/8 with one module Cat6 STP
IP 20

Broj artikla / Article No.:
14.01.277

Pakovanje / Pack:
24 kom / pcs.



Komunikaciona priključnica RJ45 8/8 sa dva modula Cat6 STP

Communication socket RJ45 8/8 with two modules Cat6 STP
IP 20

Broj artikla / Article No.:
14.01.278

Pakovanje / Pack:
24 kom / pcs.



Komunikaciona priključnica RJ45 8/8 sa jednim modulom Cat6 UTP

Communication socket RJ45 8/8 with one module Cat6 UTP
IP 20

Broj artikla / Article No.:
14.01.077

Pakovanje / Pack:
24 kom / pcs.



Komunikaciona priključnica RJ45 8/8 sa dva modula Cat6 UTP

Communication socket RJ45 8/8 with two modules Cat6 UTP
IP 20

Broj artikla / Article No.:
14.01.078

Pakovanje / Pack:
24 kom / pcs.

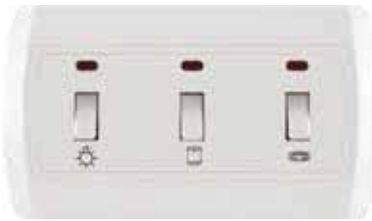

Horizontalna sklopka za kupatilo

Horizontal bathroom switch
16AX/250V; IP 20

Broj artikla / Article No.:
14.01.095

Pakovanje / Pack:
7 kom / pcs.



Vertikalna sklopka za kupatilo

Vertical bathroom switch
10AX/250V; 16AX/250V; IP 20

Broj artikla / Article No.:
14.01.096

Pakovanje / Pack:
7 kom / pcs.



Vertikalna sklopka za kupatilo sa serijskom sklopkom

Vertical bathroom switch with Two-circuit switch
10AX/250V; 16AX/250V; IP 20

Broj artikla / Article No.:
14.01.097

Pakovanje / Pack:
7 kom / pcs.



Vertikalna sklopka za kupatilo sa serijskom sklopkom i signalnim sijalicama

Vertical bathroom switch with two-circuit switch and pilot lights
10AX/250V; 16AX/250V; IP 20

Broj artikla / Article No.:
14.01.099

Pakovanje / Pack:
7 kom / pcs.



Vertikalna sklopka za kupatilo sa dvopolnom priključnicom

Vertical bathroom switch with two-pole socket-outlet
10AX/250V; 16AX/250V; IP 20

Broj artikla / Article No.:
14.01.098

Pakovanje / Pack:
7 kom / pcs.

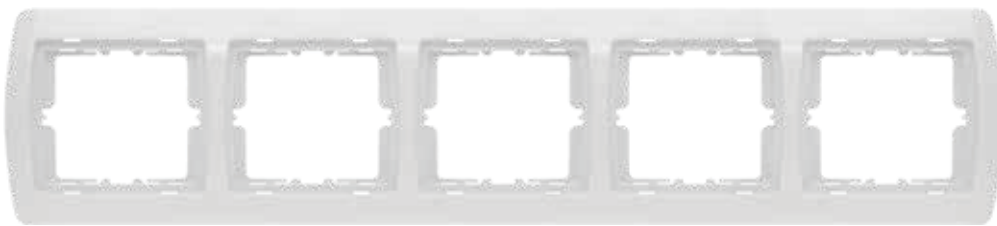

Petostruki ukrasni okvir - horizontalni
Five-set decorative frame - horizontal

Broj artikla / Article No.:
14.01.364

Pakovanje / Pack:
10 kom / pcs.



Četvorostruki ukrasni okvir - horizontalni
Quadruple decorative frame - horizontal

Broj artikla / Article No.:
14.01.363

Pakovanje / Pack:
10 kom / pcs.

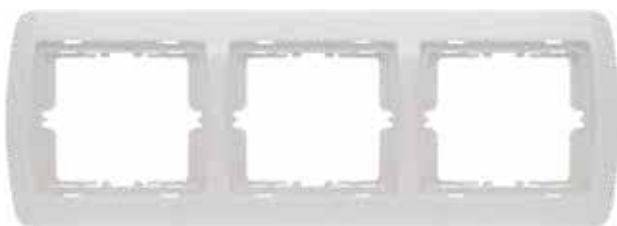

Trostruki ukrasni okvir - horizontalni
Triple decorative frame - horizontal

Broj artikla / Article No.:
14.01.362

Pakovanje / Pack:
20 kom / pcs.



Dvostruki ukrasni okvir - horizontalni
Double decorative frame - horizontal

Broj artikla / Article No.:
14.01.361

Pakovanje / Pack:
30 kom / pcs.



Petostruki ukrasni okvir - vertikalni
Five-set decorative frame - vertical

Broj artikla / Article No.:
14.01.368

Pakovanje / Pack:
10 kom / pcs.



Četvorostruki ukrasni okvir - vertikalni
Quadruple decorative frame - vertical

Broj artikla / Article No.:
14.01.367

Pakovanje / Pack:
10 kom / pcs.



Trostruki ukrasni okvir - vertikalni
Triple decorative frame - vertical

Broj artikla / Article No.:
14.01.366

Pakovanje / Pack:
20 kom / pcs.



Dvostruki ukrasni okvir - vertikalni
Double decorative frame - vertical

Broj artikla / Article No.:
14.01.365

Pakovanje / Pack:
30 kom / pcs.



109



Dvopolna priključnica "F" tip (francuski standard)

Two-pole socket-outlet "F" type (French standard)
16A/250V; IP 20

Broj artikla / Article No.:
14.01.061 [jp](#)

Pakovanje / Pack:
20 kom / pcs.



Dvopolna priključnica sa zaštitnim elementom "F" tip (francuski standard)

Two-pole socket-outlet with protection "F" type (Fr. standard)
16A/250V; IP 20

Broj artikla / Article No.:
14.01.062 [jp](#)

Pakovanje / Pack:
20 kom / pcs.



Dvopolna priključnica sa poklopcem "F" tip (francuski standard)

Two-pole socket-outlet with cover "F" type (Fr. standard)
16A/250V; IP 20

Broj artikla / Article No.:
14.01.067 [jp](#)

Pakovanje / Pack:
20 kom / pcs.



Dvopolna priključnica sa poklopcem i zaštitnim elementom "F" tip (francuski standard)

Two-pole socket-outlet with cover and protection "F" type (French standard)
16A/250V; IP 20

Broj artikla / Article No.:
14.01.079 [jp](#)

Pakovanje / Pack:
20 kom / pcs.



Dvopolna priključnica sa transparentnim poklopcem i zaštitnim elementom "F" tip (francuski standard)

Two-pole socket-outlet with cover and protection "F" type (Fr. standard)
16A/250V; IP 20

Broj artikla / Article No.:
14.01.074 [jp](#)

Pakovanje / Pack:
20 kom / pcs.



Dvostruka priključnica "F" tip (francuski standard)

Double two-pole socket-outlet "F" type (French standard)
16A/250V; IP 20

Broj artikla / Article No.:
14.01.065 [jp](#)

Pakovanje / Pack:
12 kom / pcs.



Dvostruka priključnica sa zaštitnim elementom "F" tip (francuski standard)

Double two-pole socket-outlet with protection "F" type (Fr. standard)
16A/250V; IP 20

Broj artikla / Article No.:
14.01.066 [jp](#)

Pakovanje / Pack:
12 kom / pcs.

Uklonni okviri u boji / Middle frame in various colors

	Za osnovne articke For basic articles	Pak.	Za dvostruku priklj. For double two-pole socket-outlet	Pak.	Za trofaznu priklj. For three-pole socket-outlet	Pak.	Za horiz.sklopu za kupatilo For horizontal bathroom switch	Pak.	Za vert.sklopu za kupatilo For vertical bathroom switch	Pak.
Svetlo sivi / Light grey	14.03.352	5 / 240	14.03.355	5 / 200	14.03.359	5 / 240	14.03.395	5 / 160	14.03.396	5 / 105
Krem / Cream	14.05.352	5 / 240	14.05.355	5 / 200	14.05.359	5 / 240	14.05.395	5 / 160	14.05.396	5 / 105
Bordo / Dark red	14.06.352	5 / 240	14.06.355	5 / 200	14.06.359	5 / 240	14.06.395	5 / 160	14.06.396	5 / 105

ROYAL



WINSOME DESIGN
OF ROUND
SURFACES ...





Kvalitetan mehanizam sklopki i priključnica
High quality mechanism of switches and sockets

Stepen zaštite: IP20
Protection level: IP20

Priključnice sa telom od keramike ili polikarbonata
Socket with ceramic or polycarbonate base

Sklopke sa vijčanim i bezvijčanim priključkom
Switches with screw and screwless connection

IEC 60884-1 priključnice / socket; IEC 60669-1 sklopke / switch



bv bezvijčana veza
screwless connection

jk jezgro od keramike
ceramic body

wv vijčana veza
connection with screws

jp jezgro od polikarbonata
polycarbonate body

 Prikluči se...



Jednopolna sklopka
Single-pole switch
10AX/250V; IP 20

Broj artikla / Article No.:
15.01.001  
15.01.021 

Pakovanje / Pack:
20 kom / pcs.



Jednopolna sklopka sa signalnom sijalicom
Single-pole switch with pilot light
10AX/250V; IP 20

Broj artikla / Article No.:
15.01.007  
15.01.027 

Pakovanje / Pack:
20 kom / pcs.



Serijska sklopka
Two-circuit switch
10AX/250V; IP 20

Broj artikla / Article No.:
15.01.004  
15.01.024 

Pakovanje / Pack:
20 kom / pcs.



Serijska sklopka sa signalnim sijalicama
Two-circuit switch with pilot lights
10AX/250V; IP 20

Broj artikla / Article No.:
15.01.019  
15.01.039 

Pakovanje / Pack:
20 kom / pcs.



Naizmjenična sklopka
Two-way switch
10AX/250V; IP 20

Broj artikla / Article No.:
15.01.005  
15.01.025 

Pakovanje / Pack:
20 kom / pcs.



Unakrsna sklopka
Intermediate switch
10AX/250V; IP 20

Broj artikla / Article No.:
15.01.006  
15.01.026 

Pakovanje / Pack:
20 kom / pcs.



Dvopolna sklopka
Double-pole switch
10A/250V; IP 20

Broj artikla / Article No.:
15.01.002  
15.01.022 

Pakovanje / Pack:
20 kom / pcs.



Tropolna sklopka
Three-pole switch
10A/250V; IP 20

Broj artikla / Article No.:
15.01.003  
15.01.023 

Pakovanje / Pack:
20 kom / pcs.



Dvopolna naizmjenična sklopka
Two-way double-pole switch
10A/250V; IP 20

Broj artikla / Article No.:
15.01.008  
15.01.028 

Pakovanje / Pack:
20 kom / pcs.



Dvostruka naizmjenična sklopka
Double two-way switch
10A/250V; IP 20

Broj artikla / Article No.:
15.01.009  
15.01.029 

Pakovanje / Pack:
20 kom / pcs.



Taster svetla
Light push-button
10AX/250V; IP 20

Broj artikla / Article No.:
15.01.011  
15.01.031 

Pakovanje / Pack:
20 kom / pcs.



Taster svetla sa signalnom sijalicom
Light push-button with pilot light
10AX/250V; IP 20

Broj artikla / Article No.:
15.01.013  
15.01.033 

Pakovanje / Pack:
20 kom / pcs.



Taster zvona
Bell push-button
10AX/250V; IP 20

Broj artikla / Article No.:
15.01.010 **bv**
15.01.030 **vv**

Pakovanje / Pack:
20 kom / pcs.



Taster zvona sa signalnom sijalicom
Bell push-button with Pilot light
10AX/250V; IP 20

Broj artikla / Article No.:
15.01.012 **bv**
15.01.032 **vv**

Pakovanje / Pack:
20 kom / pcs.



Taster sa pločicom za natpis sa signalnom sijalicom
Push-button with illuminated label
10A/250V; IP 20

Broj artikla / Article No.:
15.01.017 **bv**
15.01.037 **vv**

Pakovanje / Pack:
20 kom / pcs.



Taster za roletne
Blind control button
10A/250V; IP 20

Broj artikla / Article No.:
15.01.018 **bv**
15.01.038 **vv**

Pakovanje / Pack:
20 kom / pcs.



Taster SOS sa signalnom sijalicom
SOS push-button with pilot light
10A/250V; IP 20

Broj artikla / Article No.:
15.01.015 **bv**
15.01.035 **vv**

Pakovanje / Pack:
20 kom / pcs.



Potezni taster SOS
SOS push-button cord operated
10A/250V; IP 20

Broj artikla / Article No.:
15.01.020 **bv**
15.01.040 **vv**

Pakovanje / Pack:
20 kom / pcs.



Elektronski regulator svetlosti sa potencijetrom
Dimmer switch with potentiometer

Broj artikla / Article No.:
15.01.242 (230V; 60-800W)
15.01.342 (230V; 100-500W,CE)
15.01.442 (230V; 3-250W, LED)

Pakovanje / Pack:
16 kom / pcs.



Jednopolna sklopka sa preklopnikom i signalnom sijalicom
Single-pole switch with tumbler switch and pilot light
16AX/250V; IP 20

Broj artikla / Article No.:
15.01.045 **jk**

Pakovanje / Pack:
20 kom / pcs.



Dvopolna priključnica
Two-pole socket-outlet
16A/250V; IP 20

Broj artikla / Article No.:
15.01.050 **jk**
15.01.051 **jp**
15.01.074 (ekonomik) **jp**

Pakovanje / Pack:
20 kom / pcs.



Dvopolna priključnica sa zaštitnim elementom
Two-pole socket-outlet with protection
16A/250V; IP 20

Broj artikla / Article No.:
15.01.052 **jp**

Pakovanje / Pack:
20 kom / pcs.



Dvopolna priključnica sa zaštitnim elementom, crvena
Two-pole socket-outlet with protection, red
16A/250V; IP 20

Broj artikla / Article No.:
15.12.052 **jp**

Pakovanje / Pack:
20 kom / pcs.



Dvopolna priključnica sa zaštitnim elementom, zelena
Two-pole socket-outlet with protection, green
16A/250V; IP 20

Broj artikla / Article No.:
15.14.052 **jp**

Pakovanje / Pack:
20 kom / pcs.



Dvopolna priključnica sa zaštitnim elementom, narandžasta
Two-pole socket-outlet with protection, orange
16A/250V; IP 20

Broj artikla / Article No.:
15.04.052 

Pakovanje / Pack:
20 kom / pcs.



Dvopolna priključnica sa poklopcem
Two-pole socket-outlet with cover
16A/250V; IP 20

Broj artikla / Article No.:
15.01.058 
15.01.053 

Pakovanje / Pack:
20 kom / pcs.



Dvopolna priključnica sa transparentnim poklopcem
Two-pole socket-outlet with transparent cover
16A/250V; IP 20

Broj artikla / Article No.:
15.01.068 
15.01.063 

Pakovanje / Pack:
20 kom / pcs.



Dvopolna priključnica sa poklopcem i zaštitnim elementom
Two-pole socket-outlet with cover and protection
16A/250V; IP 20

Broj artikla / Article No.:
15.01.054 

Pakovanje / Pack:
20 kom / pcs.



Dvopolna priključnica sa transparentnim poklopcem i zaštitnim elementom
Two-pole socket-outlet with transparent cover and protection
16A/250V; IP 20

Broj artikla / Article No.:
15.01.064 

Pakovanje / Pack:
20 kom / pcs.



Dvostruka priključnica
Double two-pole socket-outlet
16A/250V; IP 20

Broj artikla / Article No.:
15.01.057 
15.01.055 

Pakovanje / Pack:
12 kom / pcs.



Dvostruka priključnica sa zaštitnim elementom
Double two-pole socket-outlet with protection
16A/250V; IP 20

Broj artikla / Article No.:
15.01.056 

Pakovanje / Pack:
12 kom / pcs.



Trofazna priključnica
Three-pole socket-outlet
16A/440V; IP 20

Broj artikla / Article No.:
15.01.059 

Pakovanje / Pack:
16 kom / pcs.



Telefonska priključnica RJ12 6/4 sa jednim modulom 623K
Telephone socket RJ12 6/4 with one module 623K
IP 20

Broj artikla / Article No.:
15.01.071

Pakovanje / Pack:
24 kom / pcs.



Telefonska priključnica RJ12 6/4 sa dva modula 623K
Telephone socket RJ12 6/4 with two modules 623K
IP 20

Broj artikla / Article No.:
15.01.072

Pakovanje / Pack:
24 kom / pcs.



TV priključnica sa jednim modulom
TV aerial socket with one module
IEC 169-2; CEI EN 50083-1, -2, -4;
IP 20

Broj artikla / Article No.:
15.01.088 (prolazna/feed through)
15.01.090 (završna/terminal)

Pakovanje / Pack:
24 kom / pcs.



TV priključnica sa dva modula
TV aerial socket with two modules
IEC 169-2; CEI EN 50083-1, -2, -4;
IP 20

Broj artikla / Article No.:
15.01.092 (prolazno-završna/feed through-terminal)
15.01.091 (završna/terminal)

Pakovanje / Pack:
24 kom / pcs.



Komunikaciona priključnica RJ45 8/8 sa jednim modulom Cat6 STP

Communication socket RJ45 8/8 with one module Cat6 STP
IP 20

Broj artikla / Article No.:
15.01.277



Komunikaciona priključnica RJ45 8/8 sa dva modula Cat6 STP

Communication socket RJ45 8/8 with two modules Cat6 STP
IP 20

Broj artikla / Article No.:
15.01.278



Komunikaciona priključnica RJ45 8/8 sa jednim modulom Cat6 UTP

Communication socket RJ45 8/8 with one module Cat6 UTP
IP 20

Broj artikla / Article No.:
15.01.077



Komunikaciona priključnica RJ45 8/8 sa dva modula Cat6 UTP

Communication socket RJ45 8/8 with two modules Cat6 UTP
IP 20

Broj artikla / Article No.:
15.01.078

Pakovanje / Pack:
24 kom / pcs.

Pakovanje / Pack:
24 kom / pcs.

Pakovanje / Pack:
24 kom / pcs.

Pakovanje / Pack:
24 kom / pcs.



Horizontalna sklopka za kupatilo

Horizontal bathroom switch
16AX/250V; IP 20

Broj artikla / Article No.:
15.01.095

Pakovanje / Pack:
7 kom / pcs.

**Dekorativni okviri /
Decorative frames**



	Za osnovne artikle For basic articles	Pack.	Za dvostruku i trofaznu priključnicu For double and three-pole socket-outlet	Pack.	Za horizontalnu sklopku za kupatilo For horizontal bathroom switch	Pack.
Svetlo sivi / Light grey	15.03.352	40	15.03.355	50	15.03.395	30
Krem / Cream	15.05.352	40	15.05.355	50	15.05.395	30
Bordo / Dark red	15.06.352	40	15.06.355	50	15.06.395	30



Vertikalna sklopka za kupatilo

Vertical bathroom switch
10AX/250V; 16AX/250V; IP 20

Broj artikla / Article No.:
15.01.096

Pakovanje / Pack:
7 kom / pcs.



Vertikalna sklopka za kupatilo sa serijskom sklopkom

Vertical bathroom switch with Two-circuit switch
10AX/250V; 16AX/250V; IP 20

Broj artikla / Article No.:
15.01.097

Pakovanje / Pack:
7 kom / pcs.



Vertikalna sklopka za kupatilo sa serijskom sklopkom i signalnim sijalicama

Vertical bathroom switch with two-circuit switch and pilot lights
10AX/250V; 16AX/250V; IP 20

Broj artikla / Article No.:
15.01.099

Pakovanje / Pack:
7 kom / pcs.



Vertikalna sklopka za kupatilo sa dvopolnom priključnicom

Vertical bathroom switch with two-pole socket-outlet
10AX/250V; 16AX/250V; IP20

Broj artikla / Article No.:
15.01.098

Pakovanje / Pack:
7 kom / pcs.



Petostruki ukrasni okvir - horizontalni
Five-set decorative frame - horizontal

Broj artikla / Article No.:
15.01.364

Pakovanje / Pack:
10 kom / pcs.



Četvorostruki ukrasni okvir - horizontalni
Quadruple decorative frame - horizontal

Broj artikla / Article No.:
15.01.363

Pakovanje / Pack:
10 kom / pcs.



Trostruki ukrasni okvir - horizontalni
Triple decorative frame - horizontal

Broj artikla / Article No.:
15.01.362

Pakovanje / Pack:
20 kom / pcs.



Dvostruki ukrasni okvir - horizontalni
Double decorative frame - horizontal

Broj artikla / Article No.:
15.01.361

Pakovanje / Pack:
30 kom / pcs.



Petostruki ukrasni okvir - vertikalni
Five-set decorative frame - vertical

Broj artikla / Article No.:
15.01.368

Pakovanje / Pack:
10 kom / pcs.



Četvorostruki ukrasni okvir - vertikalni
Quadruple decorative frame - vertical

Broj artikla / Article No.:
15.01.367

Pakovanje / Pack:
10 kom / pcs.



Trostruki ukrasni okvir - vertikalni
Triple decorative frame - vertical

Broj artikla / Article No.:
15.01.366

Pakovanje / Pack:
20 kom / pcs.



Dvostruki ukrasni okvir - vertikalni
Double decorative frame - vertical

Broj artikla / Article No.:
15.01.365

Pakovanje / Pack:
30 kom / pcs.

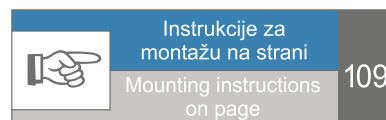

Instrukcije za
montažu na strani

Mounting instructions
on page

109



Dvopolna priključnica "F" tip
(francuski standard)
Two-pole socket-outlet "F" type
(French standard)
16A/250V; IP 20

Broj artikla / Article No.:
15.01.061

Pakovanje / Pack:
20 kom / pcs.



Dvopolna priključnica sa
zaštitnim elementom "F" tip
(francuski standard)
Two-pole socket-outlet with
protection "F" type (Fr. standard)
16A/250V; IP 20

Broj artikla / Article No.:
15.01.062

Pakovanje / Pack:
20 kom / pcs.



Dvopolna priključnica sa
poklopcem "F" tip
(francuski standard)
Two-pole socket-outlet
with cover "F" type (Fr. standard)
16A/250V; IP 20

Broj artikla / Article No.:
15.01.067

Pakovanje / Pack:
20 kom / pcs.



Dvopolna priključnica sa
poklopcem i zaštitnim elementom
"F" tip (francuski standard)
Two-pole socket-outlet with cover and
protection "F" type (French standard)
16A/250V; IP 20

Broj artikla / Article No.:
15.01.079

Pakovanje / Pack:
20 kom / pcs.



Dvopolna priključnica sa
transparentnim poklopcem i
zaštitnim elementom "F" tip
(francuski standard)
Two-pole socket-outlet with cover
and protection "F" type (Fr. standard)
16A/250V; IP 20

Broj artikla / Article No.:
15.01.074

Pakovanje / Pack:
20 kom / pcs.



Dvostruka priključnica "F"
tip (francuski standard)
Double two-pole socket-outlet
"F" type (French standard)
16A/250V; IP 20

Broj artikla / Article No.:
15.01.065

Pakovanje / Pack:
12 kom / pcs.



Dvostruka priključnica sa
zaštitnim elementom "F" tip
(francuski standard)
Double two-pole socket-outlet with
protection "F" type (Fr. standard)
16A/250V; IP 20

Broj artikla / Article No.:
15.01.066

Pakovanje / Pack:
12 kom / pcs.

Nizajući ukrasni okviri Royal u boji

		Svetlo sivi / Light grey	Krem / Cream	Bordo / Dark red	Pak.
Horizontalni / horizontal	Dvostruki okvir / Double decorative frame	15.03.361	15.05.361	15.06.361	30
	Trostruki okvir / Triple decorative frame	15.03.362	15.05.362	15.06.362	20
	Četvorstruki okvir / Quadruple dec. frame	15.03.363	15.05.363	15.06.363	10
	Petostruki okvir / Five-set decorative frame	15.03.364	15.05.364	15.06.364	10
Vertikalni / vertical	Dvostruki okvir / Double decorative frame	15.03.365	15.05.365	15.06.365	30
	Trostruki okvir / Triple decorative frame	15.03.366	15.05.366	15.06.366	20
	Četvorstruki okvir / Quadruple dec. frame	15.03.367	15.05.367	15.06.367	10
	Petostruki okvir / Five-set decorative frame	15.03.368	15.05.368	15.06.368	10

ROYAL
exclusive



LUXURIOUS DESIGN
FOR HIGH CLASS
SPAC ...





Luksuzna linija programa Royal
Luxury line of Royal program

Stepen zaštite: IP20
Protection level: IP20

Priključnice sa telom od polikarbonata
Socket with polycarbonate base

Sklopke sa bezvijčanim priključkom
Switches with screwless connection

IEC 60884-1 priključnice / socket; IEC 60669-1 sklopke / switch



bv bezvijčana veza
screwless connection

jp jezgro od polikarbonata
polycarbonate body

 **Priključi se...**



Jednopolna sklopka
Single-pole switch
10AX/250V; IP 20

Broj artikla / Article No.:
15.72.001 **bv**

Pakovanje / Pack:
20 kom / pcs.



Serijska sklopka
Two-circuit switch
10AX/250V; IP 20

Broj artikla / Article No.:
15.72.004 **bv**

Pakovanje / Pack:
20 kom / pcs.



Naizmjenična sklopka
Two-way switch
10AX/250V; IP 20

Broj artikla / Article No.:
15.72.005 **bv**

Pakovanje / Pack:
20 kom / pcs.



Unakrsna sklopka
Intermediate switch
10AX/250V; IP 20

Broj artikla / Article No.:
15.72.006 **bv**

Pakovanje / Pack:
20 kom / pcs.



**Elektronski regulator svetlosti sa
potencijetrom**
Dimmer switch with potentiometer

Broj artikla / Article No.:
15.72.242 (230V; 60-800W)
15.72.342 (230V; 100-500W,CE)
15.72.442 (230V; 3-250W, LED)

Pakovanje / Pack:
16 kom / pcs.



**Dvopolna priključnica
sa zaštitnim elementom**
Two-pole socket-outlet with
protection
16A/250V; IP 20

Broj artikla / Article No.:
15.72.052 **jp**

Pakovanje / Pack:
20 kom / pcs.



**Dvopolna priključnica sa
transparentnim poklopcem i
zaštitnim elementom**
Two-pole socket-outlet with
transparent cover and protection
16A/250V; IP 20

Broj artikla / Article No.:
15.72.064 **jp**

Pakovanje / Pack:
20 kom / pcs.



Dvostruka priključnica
Double two-pole
socket-outlet
16A/250V; IP 20

Broj artikla / Article No.:
15.72.055 **jp**

Pakovanje / Pack:
12 kom / pcs.



Trofazna priključnica
Three-pole socket-outlet
16A/440V; IP 20

Broj artikla / Article No.:
15.72.059 **jk**

Pakovanje / Pack:
16 kom / pcs.



**Telefonska priključnica RJ12
6/4 sa jednim modulom 623K**
Telephone socket RJ12 6/4 with
one module 623K
IP 20

Broj artikla / Article No.:
15.72.071

Pakovanje / Pack:
24 kom / pcs.



**Telefonska priključnica RJ12
6/4 sa dva modula 623K**
Telephone socket RJ12 6/4
with two modules 623K
IP 20

Broj artikla / Article No.:
15.72.072

Pakovanje / Pack:
24 kom / pcs.



**Komunikaciona priključnica
RJ45 8/8 sa dva modula Cat6**
Communication socket RJ45 8/8
with two modules Cat6
IP 20

Broj artikla / Article No.:
15.72.078 (Cat6 UTP)
15.72.278 (Cat6 STP)

Pakovanje / Pack:
24 kom / pcs.



TV priključnica sa jednim modulom
TV aerial socket with one module
IEC 169-2; CEI EN 50083-1, -2, -4;
IP 20

Broj artikla / Article No.:
15.72.088 (prolazna/feed through)
15.72.090 (završna/terminal)

Pakovanje / Pack:
24 kom / pcs.



TV priključnica sa dva modula
TV aerial socket with two modules
IEC 169-2; CEI EN 50083-1, -2, -4;
IP 20

Broj artikla / Article No.:
15.72.092 (prolazno-završna/feed
through-terminal)
15.72.091 (završna/terminal)

Pakovanje / Pack:
24 kom / pcs.



Horizontalna sklopka za kupatilo
Horizontal bathroom switch
16AX/250V; IP 20

Broj artikla / Article No.:
15.72.095

Pakovanje / Pack:
7 kom / pcs.



Vertikalna sklopka za kupatilo
Vertical bathroom switch
10AX/250V; 16AX/250V; IP 20
Broj artikla / Article No.:
15.72.096

Pakovanje / Pack:
7 kom / pcs.



Jednopolna sklopka
Single-pole switch
10AX/250V; IP 20

Broj artikla / Article No.:
15.71.001 **bv**

Pakovanje / Pack:
20 kom / pcs.



Serijska sklopka
Two-circuit switch
10AX/250V; IP 20

Broj artikla / Article No.:
15.71.004 **bv**

Pakovanje / Pack:
20 kom / pcs.



Naizmjenična sklopka
Two-way switch
10AX/250V; IP 20

Broj artikla / Article No.:
15.71.005 **bv**

Pakovanje / Pack:
20 kom / pcs.



Unakrsna sklopka
Intermediate switch
10AX/250V; IP 20

Broj artikla / Article No.:
15.71.006 **bv**

Pakovanje / Pack:
20 kom / pcs.



Elektronski regulator svetlosti sa potenciometrom
Dimmer switch with potentiometer

Broj artikla / Article No.:
15.71.242 (230V; 60-800W)
15.71.342 (230V; 100-500W)
15.71.442 (230V; 3-250W, LED)

Pakovanje / Pack:
16 kom / pcs.



Dvopolna priključnica sa zaštitnim elementom
Two-pole socket-outlet with protection
16A/250V; IP 20

Broj artikla / Article No.:
15.71.052 **jp**

Pakovanje / Pack:
20 kom / pcs.



Dvopolna priključnica sa transparentnim poklopcem i zaštitnim elementom
Two-pole socket-outlet with transparent cover and protection
16A/250V; IP 20

Broj artikla / Article No.:
15.71.064 **jp**

Pakovanje / Pack:
20 kom / pcs.



Dvostruka priključnica
Double two-pole socket-outlet
16A/250V; IP 20

Broj artikla / Article No.:
15.71.055 **jp**

Pakovanje / Pack:
12 kom / pcs.



Trofazna priključnica
Three-pole socket-outlet
16A/440V; IP 20

Broj artikla / Article No.:
15.71.059 

Pakovanje / Pack:
16 kom / pcs.



Telefonska priključnica RJ12
6/4 sa jednim modulom 623K
Telephone socket RJ12 6/4 with
one module 623K
IP 20

Broj artikla / Article No.:
15.71.071

Pakovanje / Pack:
24 kom / pcs.



Telefonska priključnica RJ12
6/4 sa dva modula 623K
Telephone socket RJ12 6/4
with two modules 623K
IP 20

Broj artikla / Article No.:
15.71.072

Pakovanje / Pack:
24 kom / pcs.



Komunikaciona priključnica
RJ45 8/8 sa dva modula Cat6
Communication socket RJ45 8/8
with two modules Cat6
IP 20

Broj artikla / Article No.:
15.71.078 (Cat6 UTP)
15.71.278 (Cat6 STP)

Pakovanje / Pack:
24 kom / pcs.



TV priključnica sa
jednim modulom
TV aerial socket with one module
IEC 169-2; CEI EN 50083-1, -2, -4;
IP 20

Broj artikla / Article No.:
15.71.088 (prolazna/feed through)
15.71.090 (završna/terminal)

Pakovanje / Pack:
24 kom / pcs.



TV priključnica sa dva modula
TV aerial socket with two modules
IEC 169-2; CEI EN 50083-1, -2, -4;
IP 20

Broj artikla / Article No.:
15.71.092 (prolazno-završna/feed
through-terminal)
15.71.091 (završna/terminal)

Pakovanje / Pack:
24 kom / pcs.



Horizontalna sklopka za kupatilo
Horizontal bathroom switch
16AX/250V; IP 20

Broj artikla / Article No.:
15.71.095

Pakovanje / Pack:
7 kom / pcs.



Vertikalna sklopka za
kupatilo
Vertical bathroom switch
10AX/250V; 16AX/250V; IP 20

Broj artikla / Article No.:
15.71.096

Pakovanje / Pack:
7 kom / pcs.



Petostruki ukrasni okvir - horizontalni
Five-set decorative frame - horizontal

Broj artikla / Article No.:
15.72.364 (crno/srebrni - black/silver)
15.71.364 (zlatni-gold)

Pakovanje / Pack:
10 kom / pcs.



Četvorostruki ukrasni okvir - horizontalni
Quadruple decorative frame - horizontal

Broj artikla / Article No.:
15.72.363 (crno/srebrni - black/silver)
15.71.363 (zlatni-gold)

Pakovanje / Pack:
10 kom / pcs.



Trostruki ukrasni okvir - horizontalni
Triple decorative frame - horizontal

Broj artikla / Article No.:
15.72.362 (crno/srebrni - black/silver)
15.71.362 (zlatni-gold)

Pakovanje / Pack:
20 kom / pcs.



Dvostruki ukrasni okvir - horizontalni
Double decorative frame - horizontal

Broj artikla / Article No.:
15.72.361 (crno/srebrni - black/silver)
15.71.361 (zlatni-gold)

Pakovanje / Pack:
30 kom / pcs.

Petostruki ukrasni okvir - vertikalni
Five-set decorative frame - vertical

Broj artikla / Article No.:
15.72.368 (crno/srebrni - black/silver)
15.71.368 (zlatni-gold)

Pakovanje / Pack:
10 kom / pcs.

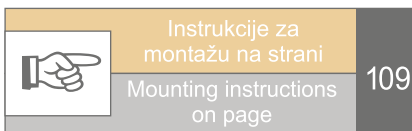

Četvorostruki ukrasni okvir - vertikalni
Quadruple decorative frame - vertical

Broj artikla / Article No.:
15.72.367 (crno/srebrni - black/silver)
15.71.367 (zlatni-gold)

Pakovanje / Pack:
10 kom / pcs.

Trostruki ukrasni okvir - vertikalni
Triple decorative frame - vertical

Broj artikla / Article No.:
15.72.366 (crno/srebrni - black/silver)
15.71.366 (zlatni-gold)

Pakovanje / Pack:
20 kom / pcs.

Dvostruki ukrasni okvir - vertikalni
Double decorative frame - vertical

Broj artikla / Article No.:
15.72.365 (crno/srebrni - black/silver)
15.71.365 (zlatni-gold)

Pakovanje / Pack:
30 kom / pcs.



EMPORIO
PURE STYLE. pure forma. PURE BEAUTY.



MODERN DESIGN
OF ROUND
SURFACES ...





Proizvodnja u skladu sa evropskim standardima
Production according with European standards

Stepen zaštite: IP20
Protection level: IP20

Matirani ukrasni okviri i tipkala
Matt surface of decorative frames and buttons

Sklopke se izrađuju sa bezvijačnim priključkom
The switches manufactured with screwless connection

IEC 60884-1 priključnice / socket; IEC 60669-1 sklopke / switch



bv bezvijačna veza
screwless connection

jk jezgro od keramike
ceramic body

vv vijčana veza
connection with screws

jp jezgro od polikarbonata
polycarbonate body

 Prikluči se...



Jednopolna sklopka
Single-pole switch
10AX/250V; IP 20

Broj artikla / Article No.:
17.01.001 

Pakovanje / Pack:
20 kom / pcs.



Jednopolna sklopka sa signalnom sijalicom
Single-pole switch with pilot light
10AX/250V; IP 20

Broj artikla / Article No.:
17.01.007 

Pakovanje / Pack:
20 kom / pcs.

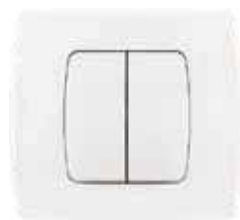

Serijska sklopka
Two-circuit switch
10AX/250V; IP 20

Broj artikla / Article No.:
17.01.004 

Pakovanje / Pack:
20 kom / pcs.



Naizmjenična sklopka
Two-way switch
10AX/250V; IP 20

Broj artikla / Article No.:
17.01.005 

Pakovanje / Pack:
20 kom / pcs.



Unakrsna sklopka
Intermediate switch
10AX/250V; IP 20

Broj artikla / Article No.:
17.01.006 

Pakovanje / Pack:
20 kom / pcs.



Taster svetla
Light push-button
10AX/250V; IP 20

Broj artikla / Article No.:
15.01.011 

Pakovanje / Pack:
20 kom / pcs.



Taster svetla sa signalnom sijalicom
Light push-button with pilot light
10AX/250V; IP 20

Broj artikla / Article No.:
17.01.013 

Pakovanje / Pack:
20 kom / pcs.



Taster zvona
Bell push-button
10AX/250V; IP 20

Broj artikla / Article No.:
17.01.010 

Pakovanje / Pack:
20 kom / pcs.



Taster zvona sa signalnom sijalicom
Bell push-button with pilot light
10AX/250V; IP 20

Broj artikla / Article No.:
17.01.012 

Pakovanje / Pack:
20 kom / pcs.



Elektronski regulator svetlosti sa potenciometrom
Dimmer switch with potentiometer

Broj artikla:
17.01.242 (230V; 60-800W)
17.01.342 (230V; 100-500W,CE)
17.01.442 (230V; 3-250W LED)

Pakovanje:
16 kom.



Jednopolna sklopka sa signalnom sijalicom i nulom
Single-pole switch with pilot light and zero contact
16AX/250V; IP 20

Broj artikla / Article No.:
17.01.645 

Pakovanje / Pack:
20 kom / pcs.



Dvopolna priključnica
Two-pole socket-outlet
16A/250V; IP 20

Broj artikla / Article No.:
17.01.050 
17.01.051 

Pakovanje / Pack:
20 kom / pcs.



Dvostruka priključnica
Double two-pole
socket-outlet
16A/250V; IP 20

Broj artikla / Article No.:
17.01.057 **jk**
17.01.055 **jp**

Pakovanje / Pack:
12 kom / pcs.



TV priključnica sa jednim modulom
TV aerial socket with one module
IEC 169-2; CEI EN 50083-1, -2, -4;
IP 20

Broj artikla / Article No.:
17.01.088 (prolazna/feed through)
17.01.090 (završna/terminal)

Pakovanje / Pack:
24 kom / pcs.



TV priključnica sa dva modula
TV aerial socket with two modules
IEC 169-2; CEI EN 50083-1, -2, -4;
IP 20

Broj artikla / Article No.:
17.01.092 (prolazno-završna/feed
through-terminal)
17.01.091 (završna/terminal)

Pakovanje / Pack:
24 kom / pcs.



Telefonska priključnica RJ12 6/4 sa jednim modulom 623K
Telephone socket RJ12 6/4 with
one module 623K
IP 20

Broj artikla / Article No.:
17.01.071

Pakovanje / Pack:
24 kom / pcs.



Telefonska priključnica RJ12 6/4 sa dva modula 623K
Telephone socket RJ12 6/4
with two modules 623K
IP 20

Broj artikla / Article No.:
17.01.072

Pakovanje / Pack:
24 kom / pcs.



Komunikaciona priključnica RJ45 8/8 sa jednim modulom Cat6
Communication socket RJ45 8/8 with
one module Cat6
IP 20

Broj artikla / Article No.:
17.01.077 (Cat6 UTP)
17.01.277 (Cat6 STP)

Pakovanje / Pack:
24 kom / pcs.



	Za osnovne artikle For basic articles	Pack.	Za dvostruku priključnicu For double two-pole socket-outlet	Pack.
Svetlo sivi / Light grey	17.03.352	70	17.03.355	60
Krem / Cream	17.05.352	70	17.05.355	60
Svetlo plavi / Light blue	17.13.352	70	17.13.355	60
Pink / Pink	17.16.352	70	17.16.355	60

bv bez vijčana veza
screwless connection

wv vijčana veza
connection with screws

jk jezgro od keramike
ceramic body

jp jezgro od polikarbonata
polycarbonate body

Happy



★ ☾
Designed for ♥
girls and boys
★ ☼





Proizvodi su namenjeni prostoru u kome borave deca
The products are designed for space where children reside

Stepen zaštite: IP20
Protection level: IP20

Širok izbor kombinacija boja, za devojčice i dečake
Wide variety of colour combinations, for girls and boys

Sve priključnice imaju ugrađenu zaštitu od dodira
All sockets have a built-in protection against touching

IEC 60884-1 priključnice / socket; IEC 60669-1 sklopke / switch



bv bezvijčana veza
screwless connection

jp jezgro od polikarbonata
polycarbonate body

 Prikluči se...



Jednopolna sklopka
Single-pole switch
Sunce / Sun
10AX/250V; IP 20

Broj artikla / Article No.:
16.61.001 

Pakovanje / Pack:
14 kom / pcs.



Serijska sklopka
Two-circuit switch
Sunce / Sun
10AX/250V; IP 20

Broj artikla / Article No.:
16.61.004 

Pakovanje / Pack:
14 kom / pcs.



Naizmenična sklopka
Two-way switch
Sunce / Sun
10AX/250V; IP 20

Broj artikla / Article No.:
16.61.005 

Pakovanje / Pack:
14 kom / pcs.



Dvopolna priključnica sa zaštitnim elementom
Two-pole socket-outlet with protection
Sunce / Sun
16A/250V; IP 20

Broj artikla / Article No.:
16.61.052 

Pakovanje / Pack:
14 kom / pcs.



Jednopolna sklopka
Single-pole switch
Cvet / Flower
10AX/250V; IP 20

Broj artikla / Article No.:
16.36.001 

Pakovanje / Pack:
14 kom / pcs.



Serijska sklopka
Two-circuit switch
Cvet / Flower
10AX/250V; IP 20

Broj artikla / Article No.:
16.36.004 

Pakovanje / Pack:
14 kom / pcs.



Naizmenična sklopka
Two-way switch
Cvet / Flower
10AX/250V; IP 20

Broj artikla / Article No.:
16.36.005 

Pakovanje / Pack:
14 kom / pcs.



Dvopolna priključnica sa zaštitnim elementom
Two-pole socket-outlet with protection
Cvet / Flower
16A/250V; IP 20

Broj artikla / Article No.:
16.36.052 

Pakovanje / Pack:
14 kom / pcs.



Jednopolna sklopka
Single-pole switch
Zvezda / Star
10AX/250V; IP 20

Broj artikla / Article No.:
16.41.001 

Pakovanje / Pack:
14 kom / pcs.



Serijska sklopka
Two-circuit switch
Zvezda / Star
10AX/250V; IP 20

Broj artikla / Article No.:
16.41.004 

Pakovanje / Pack:
14 kom / pcs.



Naizmenična sklopka
Two-way switch
Zvezda / Star
10AX/250V; IP 20

Broj artikla / Article No.:
16.41.005 

Pakovanje / Pack:
14 kom / pcs.



Dvopolna priključnica sa zaštitnim elementom
Two-pole socket-outlet with protection
Zvezda / Star
16A/250V; IP 20

Broj artikla / Article No.:
16.41.052 

Pakovanje / Pack:
14 kom / pcs.



Jednopolna sklopka
Single-pole switch
Zvezda / Star
10AX/250V; IP 20

Broj artikla / Article No.:
16.42.001 **bv**

Pakovanje / Pack:
14 kom / pcs.



Serijska sklopka
Two-circuit switch
Zvezda / Star
10AX/250V; IP 20

Broj artikla / Article No.:
16.42.004 **bv**

Pakovanje / Pack:
14 kom / pcs.



Naizmenična sklopka
Two-way switch
Zvezda / Star
10AX/250V; IP 20

Broj artikla / Article No.:
16.42.005 **bv**

Pakovanje / Pack:
14 kom / pcs.



Dvopolna priključnica sa zaštitnim elementom
Two-pole socket-outlet with protection
Zvezda / Star
16A/250V; IP 20

Broj artikla / Article No.:
16.42.052 **jp**

Pakovanje / Pack:
14 kom / pcs.



Jednopolna sklopka
Single-pole switch
Cvet / Flower
10AX/250V; IP 20

Broj artikla / Article No.:
16.33.001 **bv**

Pakovanje / Pack:
14 kom / pcs.



Serijska sklopka
Two-circuit switch
Cvet / Flower
10AX/250V; IP 20

Broj artikla / Article No.:
16.33.004 **bv**

Pakovanje / Pack:
14 kom / pcs.



Naizmenična sklopka
Two-way switch
Cvet / Flower
10AX/250V; IP 20

Broj artikla / Article No.:
16.33.005 **bv**

Pakovanje / Pack:
14 kom / pcs.



Dvopolna priključnica sa zaštitnim elementom
Two-pole socket-outlet with protection
Cvet / Flower
16A/250V; IP 20

Broj artikla / Article No.:
16.33.052 **jp**

Pakovanje / Pack:
14 kom / pcs.



Jednopolna sklopka
Single-pole switch
Cvet / Flower
10AX/250V; IP 20

Broj artikla / Article No.:
16.32.001 **bv**

Pakovanje / Pack:
14 kom / pcs.



Serijska sklopka
Two-circuit switch
Cvet / Flower
10AX/250V; IP 20

Broj artikla / Article No.:
16.32.004 **bv**

Pakovanje / Pack:
14 kom / pcs.



Naizmenična sklopka
Two-way switch
Cvet / Flower
10AX/250V; IP 20

Broj artikla / Article No.:
16.32.005 **bv**

Pakovanje / Pack:
14 kom / pcs.



Dvopolna priključnica sa zaštitnim elementom
Two-pole socket-outlet with protection
Cvet / Flower
16A/250V; IP 20

Broj artikla / Article No.:
16.32.052 **jp**

Pakovanje / Pack:
14 kom / pcs.



Jednopolna sklopka
Single-pole switch
Cvet / Flower
10AX/250V; IP 20

Broj artikla / Article No.:
16.35.001 

Pakovanje / Pack:
14 kom / pcs.



Serijska sklopka
Two-circuit switch
Cvet / Flower
10AX/250V; IP 20

Broj artikla / Article No.:
16.35.004 

Pakovanje / Pack:
14 kom / pcs.



Naizmenična sklopka
Two-way switch
Cvet / Flower
10AX/250V; IP 20

Broj artikla / Article No.:
16.35.005 

Pakovanje / Pack:
14 kom / pcs.



Dvopolna priključnica sa zaštitnim elementom
Two-pole socket-outlet with protection
Cvet / Flower
16A/250V; IP 20

Broj artikla / Article No.:
16.35.052 

Pakovanje / Pack:
14 kom / pcs.



Jednopolna sklopka
Single-pole switch
Jaje na oko / Sunny Side Up
10AX/250V; IP 20

Broj artikla / Article No.:
16.51.001 

Pakovanje / Pack:
14 kom / pcs.



Serijska sklopka
Two-circuit switch
Jaje na oko / Sunny Side Up
10AX/250V; IP 20

Broj artikla / Article No.:
16.51.004 

Pakovanje / Pack:
14 kom / pcs.



Naizmenična sklopka
Two-way switch
Jaje na oko / Sunny Side Up
10AX/250V; IP 20

Broj artikla / Article No.:
16.51.005 

Pakovanje / Pack:
14 kom / pcs.



Dvopolna priključnica sa zaštitnim elementom
Two-pole socket-outlet with protection
Jaje na oko / Sunny Side Up
16A/250V; IP 20

Broj artikla / Article No.:
16.51.052 

Pakovanje / Pack:
14 kom / pcs.



Dvostruka priključnica sa zaštitnim elementom
Double two-pole socket-outlet with protection
Jaje na oko / Sunny Side Up
16A/250V; IP 20

Broj artikla / Article No.:
16.51.056 

Pakovanje / Pack:
12 kom / pcs.





Dvopolna priključnica
sa zaštitnim elementom
"F" tip

Two-pole socket-outlet with
protection "F" type

Cvet / Flower
16A/250V; IP 20

Broj artikla / Article No.:
16.33.062 [jp](#)

Pakovanje / Pack:
14 kom / pcs.



Dvopolna priključnica
sa zaštitnim elementom
"F" tip

Two-pole socket-outlet with
protection "F" type

Cvet / Flower
16A/250V; IP 20

Broj artikla / Article No.:
16.32.062 [jp](#)

Pakovanje / Pack:
14 kom / pcs.



Dvopolna priključnica
sa zaštitnim elementom
"F" tip

Two-pole socket-outlet with
protection "F" type

Cvet / Flower
16A/250V; IP 20

Broj artikla / Article No.:
16.35.062 [jp](#)

Pakovanje / Pack:
14 kom / pcs.



Dvopolna priključnica
sa zaštitnim elementom
"F" tip

Two-pole socket-outlet with
protection "F" type

Cvet / Flower
16A/250V; IP 20

Broj artikla / Article No.:
16.36.062 [jp](#)

Pakovanje / Pack:
14 kom / pcs.



Dvopolna priključnica
sa zaštitnim elementom
"F" tip

Two-pole socket-outlet with
protection "F" type

Jaje na oko / Sunny Side Up
16A/250V; IP 20

Broj artikla / Article No.:
16.51.062 [jp](#)

Pakovanje / Pack:
14 kom / pcs.



Dvopolna priključnica
sa zaštitnim elementom
"F" tip

Two-pole socket-outlet with
protection "F" type

Zvezda / Star
16A/250V; IP 20

Broj artikla / Article No.:
16.41.062 [jp](#)

Pakovanje / Pack:
14 kom / pcs.



Dvopolna priključnica
sa zaštitnim elementom
"F" tip

Two-pole socket-outlet with
protection "F" type

Zvezda / Star
16A/250V; IP 20

Broj artikla / Article No.:
16.42.062 [jp](#)

Pakovanje / Pack:
14 kom / pcs.



Dvopolna priključnica
sa zaštitnim elementom
"F" tip

Two-pole socket-outlet with
protection "F" type

Sunce / Sun
16A/250V; IP 20

Broj artikla / Article No.:
16.61.062 [jp](#)

Pakovanje / Pack:
14 kom / pcs.



SET Q OG



PRODUCTS FOR
SURFACE
MOUNTING ...





Ugradnja na zid
Surface mounting

Stepen zaštite: IP54
Protection level: IP54

Kompletan asortiman u beloj i sivoj boji
Complete range in white and grey colour

Sklopke se izrađuju sa vijčanim i bezvijčanim priključkom
Switches are made with screw and screwless connection

IEC 60884-1 priključnice / socket; IEC 60669-1 sklopke / switch



bv bezvijčana veza
screwless connection

jk jezgro od keramike
ceramic body

wv vijčana veza
connection with screws

jp jezgro od polikarbonata
polycarbonate body

 Prikluči se...



Jednopolna sklopka
Single-pole switch
10AX/250V; IP 54

Broj artikla / Article No.:
12.01.001 
12.01.021 

Pakovanje / Pack:
20 kom / pcs.



Serijska sklopka
Two-circuit switch
10AX/250V; IP 54

Broj artikla / Article No.:
12.01.004 
12.01.024 

Pakovanje / Pack:
20 kom / pcs.



Naizmjenična sklopka
Two-way switch
10AX/250V; IP 54

Broj artikla / Article No.:
12.01.005 
12.01.025 

Pakovanje / Pack:
20 kom / pcs.



Unakrsna sklopka
Intermediate switch
10AX/250V; IP 54

Broj artikla / Article No.:
12.01.006 
12.01.026 

Pakovanje / Pack:
20 kom / pcs.



Potezni taster SOS
SOS push-button cord
operated
10AX/250V; IP 54

Broj artikla / Article No.:
12.01.020 
12.01.040 

Pakovanje / Pack:
20 kom / pcs.



Dvopolna sklopka
Double-pole switch
10AX/250V; IP 54

Broj artikla / Article No.:
12.01.002 
12.01.022 

Pakovanje / Pack:
20 kom / pcs.



Tropolna sklopka
Three-pole switch
10AX/250V; IP 54

Broj artikla / Article No.:
12.01.003 
12.01.023 

Pakovanje / Pack:
20 kom / pcs.



Dvopolna naizmjenična sklopka
Two-way double-pole switch
10AX/250V; IP 54

Broj artikla / Article No.:
12.01.008 
12.01.028 

Pakovanje / Pack:
20 kom / pcs.



Dvostruka naizmjenična sklopka
Double two-way switch
10AX/250V; IP 54

Broj artikla / Article No.:
12.01.009 
12.01.029 

Pakovanje / Pack:
20 kom / pcs.



Taster svetla
Light push-button
10AX/250V; IP 54

Broj artikla / Article No.:
12.01.011 
12.01.031 

Pakovanje / Pack:
20 kom / pcs.



Taster zvona
Bell push-button
10AX/250V; IP 54

Broj artikla / Article No.:
12.01.010 
12.01.030 

Pakovanje / Pack:
20 kom / pcs.



Taster za roletne
Blind control button
10AX/250V; IP 54

Broj artikla / Article No.:
12.01.018 
12.01.038 

Pakovanje / Pack:
20 kom / pcs.



Razvodna kutija sa 4 uvoda
Junction box with 4 channels
IP 54

Broj artikla / Article No.:
12.01.070

Pakovanje / Pack:
20 kom / pcs.



Dvopolna priključnica
Two-pole socket-outlet
16A/250V; IP 54

Broj artikla / Article No.:

12.01.050

12.01.051

Pakovanje / Pack:
20 kom / pcs.



Dvostruka horizontalna priključnica
Double horizontal two-pole socket-outlet
16A/250V; IP 54

Broj artikla / Article No.:

12.01.052

12.01.053

Pakovanje / Pack:
10 kom / pcs.



Dvostruka vertikalna priključnica
Double vertical two-pole socket-outlet
16A/250V; IP 54

Broj artikla / Article No.:

12.01.057

12.01.058

Pakovanje / Pack:
10 kom / pcs.



Trofazna priključnica
Three-pole socket-outlet
16A/440V; IP 54

Broj artikla / Article No.:

12.01.059

Pakovanje / Pack:
14 kom / pcs.



Jednopolna sklopka
Single-pole switch
10AX/250V; IP 54

Broj artikla / Article No.:

12.23.001

12.23.021

Pakovanje / Pack:
20 kom / pcs.



Serijska sklopka
Two-circuit switch
10AX/250V; IP 54

Broj artikla / Article No.:

12.23.004

12.23.024

Pakovanje / Pack:
20 kom / pcs.



Naizmenična sklopka
Two-way switch
10AX/250V; IP 54

Broj artikla / Article No.:

12.23.005

12.23.025

Pakovanje / Pack:
20 kom / pcs.



Unakrsna sklopka
Intermediate switch
10AX/250V; IP 54

Broj artikla / Article No.:

12.23.006

12.23.026

Pakovanje / Pack:
20 kom / pcs.



Potezni taster SOS
SOS push-button cord operated
10AX/250V; IP 54

Broj artikla / Article No.:

12.23.020

12.23.040

Pakovanje / Pack:
20 kom / pcs.



Dvopolna sklopka
Double-pole switch
10AX/250V; IP 54

Broj artikla / Article No.:

12.23.002

12.23.022

Pakovanje / Pack:
20 kom / pcs.



Tropolna sklopka
Three-pole switch
10AX/250V; IP 54

Broj artikla / Article No.:

12.23.003

12.23.023

Pakovanje / Pack:
20 kom / pcs.



Dvopolna naizmenična sklopka
Two-way double-pole switch
10AX/250V; IP 54

Broj artikla / Article No.:

12.23.008

12.23.028

Pakovanje / Pack:
20 kom / pcs.



Dvostruka naizmenična sklopka
Double two-way switch
10AX/250V; IP 54

Broj artikla / Article No.:

12.23.009

12.23.029

Pakovanje / Pack:
20 kom / pcs.



Taster svetla
Light push-button
10AX/250V; IP 54

Broj artikla / Article No.:
12.23.011 
12.23.031 

Pakovanje / Pack:
20 kom / pcs.



Taster zvona
Bell push-button
10AX/250V; IP 54

Broj artikla / Article No.:
12.23.010 
12.23.030 

Pakovanje / Pack:
20 kom / pcs.



Taster za roletne
Blind control button
10AX/250V; IP 54

Broj artikla / Article No.:
12.23.018 
12.23.038 

Pakovanje / Pack:
20 kom / pcs.



Razvodna kutija sa 4 uvoda
Junction box with 4 channels
IP 54

Broj artikla / Article No.:
12.23.070

Pakovanje / Pack:
20 kom / pcs.



Dvopolna priključnica
Two-pole socket-outlet
16A/250V; IP 54

Broj artikla / Article No.:
12.23.050 
12.23.051 

Pakovanje / Pack:
20 kom / pcs.



Dvostruka horizontalna priključnica
Double horizontal two-pole socket-outlet
16A/250V; IP 54

Broj artikla / Article No.:
12.23.052 
12.23.053 

Pakovanje / Pack:
10 kom / pcs.



Dvostruka vertikalna priključnica
Double vertical two-pole socket-outlet
16A/250V; IP 54

Broj artikla / Article No.:
12.23.057 
12.23.058 

Pakovanje / Pack:
10 kom / pcs.



Trofazna priključnica
Tree-pole socket-outlet
16A/440V; IP 54

Broj artikla / Article No.:
12.23.059 

Pakovanje / Pack:
14 kom / pcs.

DIMENZIJE ZA UGRADNJU

MOUNTING INSTRUCTIONS

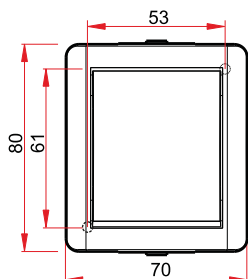

Sklopke/Switches

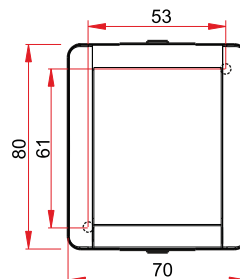
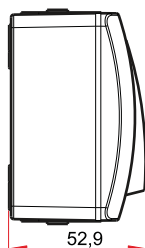

Priključnice/Socket-outlets

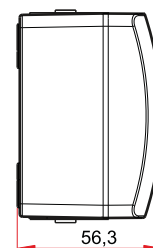



Dvopolna priključnica "F" tip
Two-pole socket-outlet "F" type
16A/250V; IP 54

Broj artikla / Article No.:
12.01.061 [JP](#)
(French standar)

Pakovanje / Pack:
20 kom / pcs.



**Dvopolna priključnica sa
zaštitom "F" tip**
Two-pole socket-outlet with
protection "F" type
16A/250V; IP 54

Broj artikla / Article No.:
12.01.062 [JP](#)
(French standar)

Pakovanje / Pack:
20 kom / pcs.



**Dvostruka horizontalna
priključnica "F" tip**
Double horizontal
two-pole socket-outlet "F" type
16A/250V; IP 54

Broj artikla / Article No.:
12.01.065 [JP](#)
(French standar)

Pakovanje / Pack:
10 kom / pcs.



**Dvostruka vertikalna
priključnica "F" tip**
Double vertical two-pole
socket-outlet "F" type
16A/250V; IP 54

Broj artikla / Article No.:
12.01.068 [JP](#)
(French standar)

Pakovanje / Pack:
10 kom / pcs.



Dvopolna priključnica "F" tip
Two-pole socket-outlet "F" type
16A/250V; IP 54

Broj artikla / Article No.:
12.23.061 [JP](#)
(French standar)

Pakovanje / Pack:
20 kom / pcs.



**Dvopolna priključnica sa
zaštitom "F" tip**
Two-pole socket-outlet with
protection "F" type
16A/250V; IP 54

Broj artikla / Article No.:
12.23.062 [JP](#)
(French standar)

Pakovanje / Pack:
20 kom / pcs.



**Dvostruka horizontalna
priključnica "F" tip**
Double horizontal
two-pole socket-outlet "F" type
16A/250V; IP 54

Broj artikla / Article No.:
12.23.065 [JP](#)
(French standar)

Pakovanje / Pack:
10 kom / pcs.



**Dvostruka vertikalna
priključnica "F" tip**
Double vertical two-pole
socket-outlet "F" type
16A/250V; IP 54

Broj artikla / Article No.:
12.23.068 [JP](#)
(French standar)

Pakovanje / Pack:
10 kom / pcs.

**ŠEMA SPOJA DVOSTRUKE PRIKLJUČNICE
WIRING OF DOUBLE HORIZONTAL SOCKET-OUTLET SET Q OG**

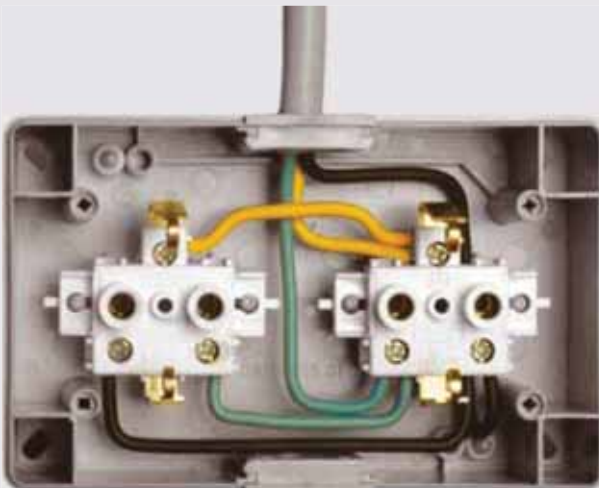

Dvostruki uvodnik
Coupling gland
SetQ OG/Mini OG

Broj artikla / Article No.:
12.01.071

Pakovanje / Pack:
5 kom / pcs.

mini DG



SMALL DIMENSIONS
OF PRODUCTS
FOR SURFACE
MOUNTING ...





Ugradnja na zid
Surface mounting

Stepen zaštite: IP54
Protection level: IP54

Male dimenzije - 60x70mm
Small dimensions - 60 x 70mm

Sklopke se izrađuju sa vijčanim i bezvijčanim priključkom
Switches are made with screw and screwless connection

IEC 60884-1 priključnice / socket; IEC 60669-1 sklopke / switch



bv bezvijčana veza
screwless connection

wv vijčana veza
connection with screws

jk jezgro od keramike
ceramic body

jp jezgro od polikarbonata
polycarbonate body

 **Priključi se...**



Jednopolna sklopka
Single-pole switch
10AX/250V; IP 54

- Broj artikla / Article No.:
- 18.01.001 (belo/white) bv
 - 18.01.021 (belo/white) vv
 - 18.23.001 (sivo/gray) bv
 - 18.23.021 (sivo/gray) vv

Pakovanje / Pack:
24 kom / pcs.



Serijska sklopka
Two-circuit switch
10AX/250V; IP 54

- Broj artikla / Article No.:
- 18.01.004 (belo/white) bv
 - 18.01.024 (belo/white) vv
 - 18.23.004 (sivo/gray) bv
 - 18.23.024 (sivo/gray) vv

Pakovanje / Pack:
24 kom / pcs.



Naizmenična sklopka
Two-way switch
10AX/250V; IP 54

- Broj artikla / Article No.:
- 18.01.005 (belo/white) bv
 - 18.01.025 (belo/white) vv
 - 18.23.005 (sivo/gray) bv
 - 18.23.025 (sivo/gray) vv

Pakovanje / Pack:
24 kom / pcs.



Unakrsna sklopka
Intermediate switch
10AX/250V; IP 54

- Broj artikla / Article No.:
- 18.01.006 (belo/white) bv
 - 18.01.026 (belo/white) vv
 - 18.23.006 (sivo/gray) bv
 - 18.23.026 (sivo/gray) vv

Pakovanje / Pack:
24 kom / pcs.



Dvopolna sklopka
Double-pole switch
10AX/250V; IP 54

- Broj artikla / Article No.:
- 18.01.002 (belo/white) bv
 - 18.01.022 (belo/white) vv
 - 18.23.002 (sivo/gray) bv
 - 18.23.022 (sivo/gray) vv

Pakovanje / Pack:
24 kom / pcs.



Taster svetla
Light push-button
10AX/250V; IP 54

- Broj artikla / Article No.:
- 18.01.011 (belo/white) bv
 - 18.01.031 (belo/white) vv
 - 18.23.011 (sivo/gray) bv
 - 18.23.031 (sivo/gray) vv

Pakovanje / Pack:
24 kom / pcs.



Taster zvona
Bell push-button
10AX/250V; IP 54

- Broj artikla / Article No.:
- 18.01.010 (belo/white) bv
 - 18.01.030 (belo/white) vv
 - 18.23.010 (sivo/gray) bv
 - 18.23.030 (sivo/gray) vv

Pakovanje / Pack:
24 kom / pcs.



Taster za roletne
Blind control button
10AX/250V; IP 54

- Broj artikla / Article No.:
- 18.01.018 (belo/white) bv
 - 18.01.038 (belo/white) vv
 - 18.23.018 (sivo/gray) bv
 - 18.23.038 (sivo/gray) vv

Pakovanje / Pack:
24 kom / pcs.



Jednopolna sklopka
Two-pole socket-outlet
16A/250V; IP 54

- Broj artikla / Article No.:
- 18.01.050 (belo/white) jk
 - 18.01.051 (belo/white) jp
 - 18.23.050 (sivo/gray) jk
 - 18.23.051 (sivo/gray) jp

Pakovanje / Pack:
24 kom / pcs.



Dvostruka horizontalna priključnica
Double horizontal two-pole socket-outlet
16A/250V; IP 54

- Broj artikla / Article No.:
- 18.01.052 (belo/white) jk
 - 18.01.053 (belo/white) jp
 - 18.23.052 (sivo/gray) jk
 - 18.23.053 (sivo/gray) jp

Pakovanje / Pack:
14 kom / pcs.



Dvostruka vertikalna priključnica
Double vertical two-pole socket-outlet
16A/250V; IP 54

- Broj artikla / Article No.:
- 18.01.057 (belo/white) jk
 - 18.01.058 (belo/white) jp
 - 18.23.057 (sivo/gray) jk
 - 18.23.058 (sivo/gray) jp

Pakovanje / Pack:
12 kom / pcs.



Razvodna kutija sa 6 uvoda
Distribution box with 6 channels
IP 54

- Broj artikla / Article No.:
- 18.01.070 (belo/white)
 - 18.23.070 (sivo/gray)

Pakovanje / Pack:
20 kom / pcs.

Structure of IP code

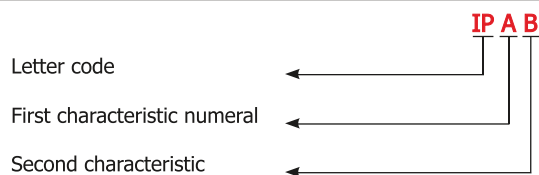

When is not required to specify the characteristic number, number is replaced with the letter

IP code elements and their meaning		
First characteristic numeral	Brief description	Definition
0	Non-protected	/
1	Protected against access to hazardous parts with back of hand	The object probe, sphere of Ø 50mm, shall not fully penetrate
2	Protected against access to hazardous parts with finger	The object probe, sphere of Ø 12,5mm, shall not fully penetrate in housing
3	Protected against access to hazardous parts with tool	The object probe, sphere of Ø 2,5mm, shall not penetrate in housing
4	Protected against access to hazardous parts with wire	The object probe, sphere of Ø 1,0mm, shall not penetrate at all in housing
5	Protected against access to hazardous parts with wire	Ingress of dust is not totally prevented, but dust shall not penetrate in a quantity to interfere with satisfactory operation of the apparatus or to impair safety
6	Protected against access to hazardous parts with wire	No ingress of dust

Second characteristic numeral	Brief description	Definition
0	Non-protected	/
1	Protected against vertically falling water drops	Vertically falling drops shall have no harmful effects
2	Protected against vertically falling water drops when enclosure tilted up to 15°	Vertically falling drops shall have no harmful effects when the enclosure is tilted at any angle up to 15° on either side of the vertical
3	Protected against spraying water	Water sprayed at an angle up to 60° on either side of the vertical shall have no harmful effects
4	Protected against splashing water	Water splashed against the enclosure from any direction shall have no harmful effects
5	Protected against water jets	Water projected in jets against the enclosure from any direction shall have no harmful effects
6	Protected against powerful water jets	Water projected in powerful jets against the enclosure from any direction shall have no harmful effects
7	Protected against the effects of temporary immersion in water	Ingress of water in quantities causing harmful effects shall not be possible when the enclosure is temporarily immersed in water under standardized conditions of pressure and time
8	Protected against the effects of continuous immersion in water	Ingress of water in quantities causing harmful effects shall not be possible when the enclosure is continuously immersed in water under conditions which shall be agreed between manufacturer and user but which are more severe than for numeral 7

DIMENZIJE ZA UGRADNJU

MOUNTING INSTRUCTIONS

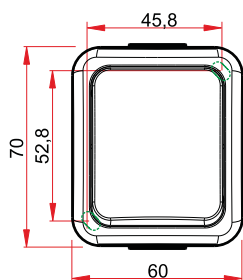

Sklopke/Switches

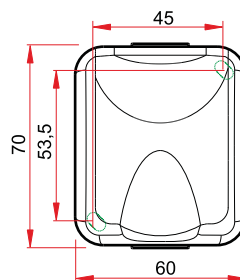
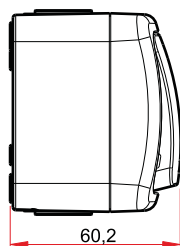

Prikjučnice/Socket-outlets

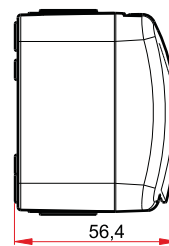

Razvodne table
Distribution panels



SIMPLE AND
FAST ASSEMBLY ...





Proizvodnja u skladu sa evropskim standardima
Production according with European standards

Stepen zaštite: IP40
Protection level: IP40

Modeli za 4, 8, 12, 24 i 36 automatskih osigurača
Models for 4, 8, 12, 24 and 36 miniature circuit breakers

Svaki red automatskih prekidača ima zasebna vrata
Each row of circuit breakers has a separate door

IEC 60670; CEI EN 60529

RoHS 
compliant





DVOSTRUKO IZOLOVANE REDNE KLEME
DOUBLE INSULATED TERMINAL BLOCKS

DIN ŠINA
DIN RAILS

IP40







GWT
960°C

RoHS
compliant 

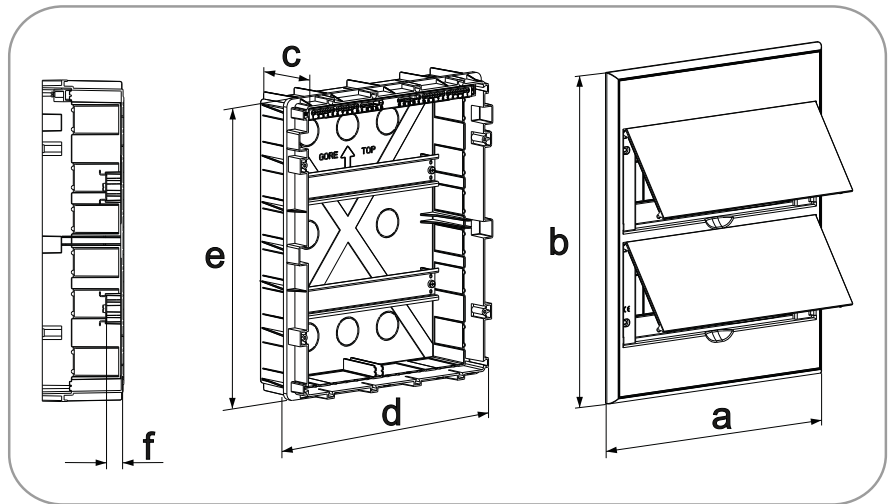
MUT

ugradnja u zid
flush assembling





	a (mm)	b (mm)	c (mm)	d (mm)	e (mm)	f (mm)			
MUT 4	156	240	86	146	230	15	1	4	2x5
MUT 8	228	240	86	218	230	15	1	8	2x5
MUT 12	300	240	86	290	215	15	1	12	2x10
MUT 24	300	365	85	276	332	15	2	24	2x13
MUT 36	300	530	85	276	502	15	3	36	2x15

MAT

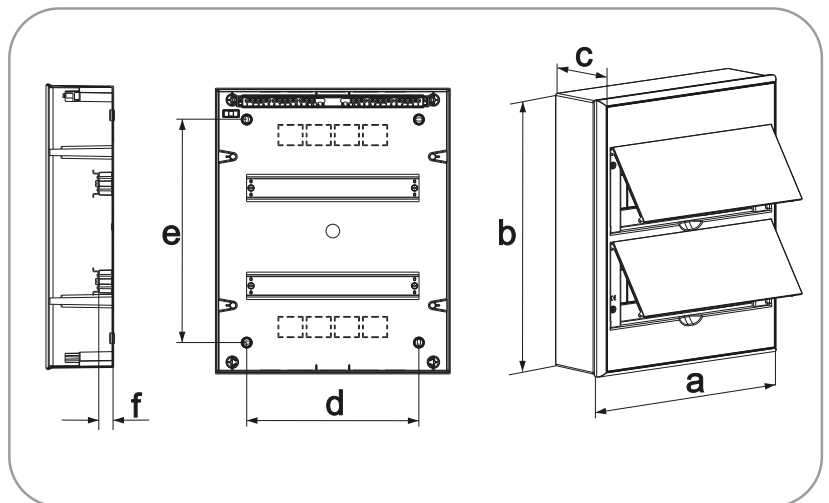
ugradnja na zid
surface assembling



	a (mm)	b (mm)	c (mm)	d (mm)	e (mm)	f (mm)			
MAT 4	156	240	100	96	160	15	1	4	2x5
MAT 8	228	240	100	166	140	15	1	8	2x5
MAT 12	300	240	100	220	174	15	1	12	2x10
MAT 24	300	365	100	220	285	15	2	24	2x13
MAT 36	300	530	100	220	450	15	3	36	2x15



Razvodna tabla MUT 4
Distribution panel MUT 4
Ugradnja u zid/flush assembling
IP 40

Broj artikla / Article No.:
 05.66.81
 05.66.11

Pakovanje / Pack:
24 kom / pcs.



Razvodna tabla MUT 8
Distribution panel MUT 8
Ugradnja u zid/flush assembling
IP 40

Broj artikla / Article No.:
 05.65.81
 05.65.11

Pakovanje / Pack:
12 kom / pcs.

Razvodna tabla MUT 12
Distribution panel MUT 12
Ugradnja u zid/flush assembling
IP 40

Broj artikla / Article No.:
 05.60.81
 05.60.11

Pakovanje / Pack:
12 kom / pcs.



Razvodna tabla MUT 24
Distribution panel MUT 24
Ugradnja u zid/flush assembling
IP 40

Broj artikla / Article No.:
 05.61.81
 05.61.11

Pakovanje / Pack:
8 kom / pcs.



Razvodna tabla MUT 36
Distribution panel MUT 36
Ugradnja u zid/flush assembling
IP 40

Broj artikla / Article No.:
 05.64.81
 05.64.11

Pakovanje / Pack:
4 kom / pcs.





Razvodna tabla MAT 4
 Distribution panel MAT 4
 Ugradnja na zid/surface assembling
 IP 40

Broj artikla / Article No.:
 05.69.81
 05.69.11

Pakovanje / Pack:
 24 kom / pcs.



Razvodna tabla MAT 8
 Distribution panel MAT 8
 Ugradnja na zid/surface assembling
 IP 40

Broj artikla / Article No.:
 05.68.81
 05.68.11

Pakovanje / Pack:
 12 kom / pcs.

Razvodna tabla MAT 12
 Distribution panel MAT 12
 Ugradnja na zid/surface assembling
 IP 40

Broj artikla / Article No.:
 05.62.81
 05.62.11

Pakovanje / Pack:
 12 kom / pcs.



Razvodna tabla MAT 24
 Distribution panel MAT 24
 Ugradnja na zid/surface assembling
 IP 40

Broj artikla / Article No.:
 05.63.81
 05.63.11

Pakovanje / Pack:
 8 kom / pcs.



Razvodna tabla MAT 36
 Distribution panel MAT 36
 Ugradnja na zid/surface assembling
 IP 40

Broj artikla / Article No.:
 05.67.81
 05.67.11

Pakovanje / Pack:
 4 kom / pcs.

instalacione kutije junction boxes



Montažna kutija Ø60mm
Mounting box Ø60mm
Dubina kutije/Box depth:43mm

Broj artikla / Article No.:
01.43.00
Ugradnja u zid/Flush
assembling

Pakovanje / Pack:
200 kom / pcs.



**Nizajuća montažna
Kutija Ø60mm**
Mounting box for multiple
frames Ø60mm
Dubina kutije/
Box depth:43mm

Broj artikla / Article No.:
05.00.001
Ugradnja u zid/Flush
assembling

Pakovanje / Pack:
420 kom / pcs.



**Nizajuća duboka
montažna kutija Ø60mm**
Mounting box for multiple
frames Ø60 mm - deep
Dubina kutije/
Box depth:65mm

Broj artikla / Article No.:
05.00.012
Ugradnja u zid/Flush
assembling

Pakovanje / Pack:
330 kom / pcs.



**Montažna kutija za
tropolnu priključnicu**
Mounting box for three-pole
socket-outlet
Dubina kutije/
Box depth:43mm

Broj artikla / Article No.:
01.11.02
Ugradnja u zid/Flush
assembling

Pakovanje / Pack:
300 kom / pcs.



**Montažna kutija
Ø78mm**
Mounting box Ø78mm
Dubina kutije/
Box depth:43mm

Broj artikla / Article No.:
01.42.00
Ugradnja u zid/Flush
assembling

Pakovanje / Pack:
252 kom / pcs.



**Instalaciona kutija
141x77x40mm (za kupatilo)**
Mounting box 141x77mm
(for bathroom switch)

Broj artikla / Article No.:
01.73.00
Ugradnja u zid/Flush
assembling

Pakovanje / Pack:
215 kom / pcs.



**Razvodna kutija
81x81x40mm sa 12 uvoda**
Junction box 81 x 81mm,
with 12 channels
IP 54

Broj artikla / Article No.:
50.01.001
Ugradnja na zid/Surface
assembling

Pakovanje / Pack:
20 kom / pcs.



**Razvodna kutija
100x100x50mm**
Junction box
100x100x50mm
IP 40

Broj artikla / Article No.:
08.10.00
Ugradnja u zid/Flush
assembling

Pakovanje / Pack:
8 kom / pcs.



**Razvodna kutija
156x240x82mm**
Junction box
156x240x82mm
IP 40

Broj artikla / Article No.:
08.04.01
Ugradnja u zid/Flush
assembling

Pakovanje / Pack:
24 kom / pcs.



**Razvodna kutija
156x240x84mm**
Junction box
156x240x84mm
IP 54

Broj artikla / Article No.:
08.06.01
Ugradnja na zid/Surface
assembling

Pakovanje / Pack: pakovanje / Pack:
24 kom / pcs. 50 kom / pcs.



**Razvodna kutija
228x240x82mm**
Junction box
228x240x82mm
IP 40

Broj artikla / Article No.:
08.05.01
Ugradnja u zid/Flush
assembling

Pakovanje / Pack:
15 kom / pcs.



**Razvodna kutija
228x240x84mm**
Junction box
228x240x84mm
IP 40

Broj artikla / Article No.:
08.07.01
Ugradnja na zid/Surface
assembling

Pakovanje / Pack:
15 kom / pcs.



Kutija za stalni priključak
Junction box for fixed
connection
Dubina kutije/Box depth:43mm
IP 44

Broj artikla / Article No.:
01.55.00
Ugradnja u zid/Flush
assembling

Pakovanje / Pack:
24 kom / pcs.



**Kutija za izjednačavanje
potencijala 100x100x50mm**
Box of equalization of
potentials 100x100x50mm
IP 40

Broj artikla / Article No.:
08.11.01
Ugradnja u zid/Flush
assembling

Pakovanje / Pack:
8 kom / pcs.

elektro pribor electrical accessories



Dvopolni utikač

Two-pole plug
16A/250V
"L" tip

Broj artikla / Article No.:
51.01.021 (bela/white)
51.15.021 (crna/black)

Pakovanje / Pack:
70 kom / pcs.



Trofazni utikač

Three-pole plug
16A/440V
"L" tip

Broj artikla / Article No.:
51.01.031 (bela/white)
51.15.031 (crna/black)

Pakovanje / Pack:
30 kom / pcs.



Zaštitnik za dvopolnu
priključnicu
Shutter for two-pole
socket-outlet

Broj artikla / Article No.:
06.51.01

Pakovanje / Pack:
50/2000 kom / pcs.



Obujmica OG 8-18mm
Cable holder OG 8-18mm

Broj artikla / Article No.:
01.44.01

Pakovanje / Pack:
50/3500 kom / pcs.



Redna stezaljka

Terminal block
Izrađen od keramike/
Made of ceramics.
SRPS EN 60998-1

Broj artikla / Article No.:
04.03.00 (tropolna/three-pole)
04.05.00 (petopolna/five-pole)
04.06.00 (šestopolna/six-pole)

Pakovanje / Pack:
5 kom / pcs.



Jednopolna sklopka sa
preklopnikom za ugradnju
Single-pole tumbler switch
with pilot light for building in
16AX/250V

Broj artikla / Article No.:
01.72.10

Pakovanje / Pack:
60 kom / pcs.



Zaštitnik za zid od prljanja
Wall protection plate

Broj artikla / Article No.:
06.00.001
(transparentan/transparent)
06.01.001 (beli/white)

Pakovanje / Pack:
5/90 kom / pcs.



Dvopolni utikač

Two-pole plug
16A/250V
"I" tip

Broj artikla / Article No.:
51.01.022

Pakovanje / Pack:
50 kom / pcs.



Dvopolni utikač

Two-pole plug
16A/250V
"I" tip

Broj artikla / Article No.:
51.01.023

Pakovanje / Pack:
50 kom / pcs.



Dvopolna prenosna priključnica

Two-pole portable socket-outlet
16A/250V

Broj artikla / Article No.:
51.01.024

Pakovanje / Pack:
40 kom / pcs.

**Prenosne
priključnice
Portable socket**

**SAFETY
CONNECTIONS ...**



Proizvodnja u skladu sa evropskim standardima
Production according with European standards

Moderan dizajn
Modern design

Modeli sa 3, 4, 5 i 6 priključna mesta
Models with 3, 4, 5 and 6 outlets

max 3500W, 16A
max 3500W, 16A

with
USB
connections

 Priključite se...



Safety Connections

NEW



Četvorostruka prenosna priključnica sa savitljivim kablom i pregibnom sklopkom+prenaponska zaštita
Portable socket-outlet with 4 outlets and switch+Surge Protection
16A/250V; max 3500W; 3x1,5mm²
Prenaponska zaštita max 13500A

Broj artikla / Article No.:
01.42.015 (cable length 1,5m)

Pakovanje / Pack:
12 kom / pcs.



Priključnica sa prenaponskom zaštitom
Surge Protected Socket
16A/250V; max3500W; max13500A

Broj artikla / Article No.:
07.01.001

Pakovanje / Pack:
24 kom / pcs.



beli
white

Sivi
grey

crni
black

Petostruka prenosna priključnica sa pregibnom sklopkom+2 USB priključka+prenaponska zaštita
Earthed 5 gang group socket with switch + 2USB+Surge Protection
16A/250V; max 3500W; 3x1,5mm²
Prenaponska zaštita max 13500A

Broj artikla / Article No.:

- 01.01.015 (bela/white) cable length 1,5m
- 01.23.015 (siva/gray) cable length 1,5m
- 01.15.015 (crna/black) cable length 1,5m

Pakovanje / Pack:
12 kom / pcs.

with
USB
connections



Priključnica sa prenaponskom zaštitom + 2 USB priključka
Surge Protected Socket + USB conector
16A/250V; max 3500W; max 13500A

Broj artikla / Article No.:

- 07.01.002 (bela/white)
- 07.23.002 (siva/gray)
- 07.15.002 (crna/black)

Pakovanje / Pack:
24 kom / pcs.

prenosne priključnice sa savitljivim kablom



Trostruka prenosna priključnica sa savitljivim kablom

Portable socket-outlet with 3 outlets
16A/250V; max 3500W

Broj artikla / Article No.:
01.30.015 (L=1,5m; 3x1,0mm²)
01.30.030 (L=3m; 3x1,5mm²)

Pakovanje / Pack:
12 kom / pcs.



Trostruka prenosna priključnica sa savitljivim kablom i pregibnom sklopkom

Portable socket-outlet with 3 outlets
and switch
16A/250V; max 3500W

Broj artikla / Article No.:
01.31.015 (L=1,5m; 3x1,0mm²)
01.31.030 (L=3m; 3x1,5mm²)
01.31.050 (L=5m; 3x1,5mm²)

Pakovanje / Pack:
12 kom / pcs.



Četvorstruka prenosna priklj. sa savitljivim kablom

Portable socket-outlet with 4
outlets
16A/250V; max 3500W

Broj artikla / Article No.:
01.40.015 (L=1,5m; 3x1,5mm²)

Pakovanje / Pack:
12 kom / pcs.



Četvorstruka prenosna priklj. sa savitljivim kablom i pregibnom sklopkom

Portable socket-outlet with 4
outlets and switch
16A/250V; max 3500W

Broj artikla / Article No.:
01.41.015 (L=1,5m; 3x1,5mm²)
01.41.030 (L=3m; 3x1,5mm²)
01.41.050 (L=5m; 3x1,5mm²)

Pakovanje / Pack:
12 kom / pcs.



Šestostruka prenosna priključnica sa savitljivim kablom

Portable socket-outlet with 6
outlets
16A/250V; max 3500W

Broj artikla / Article No.:
01.60.015 (L=1,5m; 3x1,5mm²)

Pakovanje / Pack:
12 kom / pcs.



Šestostruka prenosna priklj. sa savitljivim kablom i pregibnom sklopkom

Portable socket-outlet with 6
outlets and switch
16A/250V; max 3500W

Broj artikla / Article No.:
01.61.015 (L=1,5m; 3x1,5mm²)
01.61.030 (L=3m; 3x1,5mm²)
01.61.050 (L=5m; 3x1,5mm²)

Pakovanje / Pack:
12 kom / pcs.



Trostruka priklj.sa utikačem i pregibnom sklopkom

3 gang witch switch plug Socket
16A/250V; max 3500W

Broj artikla / Article No.:
01.31.000

Pakovanje / Pack:
20 kom / pcs.



Dvostruka priključnica sa utikačem

2 Gang-Plug Socket
16A/250V; max 3500W

Broj artikla / Article No.:
07.01.022

Pakovanje / Pack:
25 kom / pcs.



Trostruka priključnica sa utikačem

3 Gang-Plug Socket
16A/250V; max 3500W

Broj artikla / Article No.:
07.01.023

Pakovanje / Pack:
20 kom / pcs.



T-razvodnik

T-adaptor
16A/250V; max 3500W

Broj artikla / Article No.:
07.01.002 (2P)
07.01.003 (3P)

Pakovanje / Pack:
16 kom / pcs.

Office
series

SOCKET OUTLET
FOR OFFICE ...

Moderan dizajn
Modern Design

Veliki izbor boja
Color Options

Mogućnost kombinovanja
Can be combined

Velika otpornost
High resistant



vijčana veza
connection with screws



jezgro od polikarbonata
polycarbonate body

 Priključite se...



Office-V

Sklop utičnica za stolove - 3 utičnice+1cat6+1cat3
 Desktop socket system - 3 socket+1cat6+1cat3

Broj artikla / Article No.:

- 26.01.001 (1 kom/pcs.)
- 26.23.001 (1 kom/pcs.)
- 26.15.001 (1 kom/pcs.)
- 26.75.001 (1 kom/pcs.)



Dimenzije za montažu
 Mounting Size

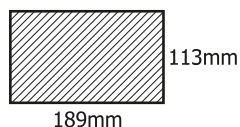

Office-Fx

Sklop utičnica za stolove - 2 utičnice+1cat6+1,5m kabl
 Desktop socket system - 2 socket+1cat6+1,5m cable

Broj artikla / Article No.:

- 26.01.002 (1 kom/pcs.)
- 26.23.002 (1 kom/pcs.)
- 26.15.002 (1 kom/pcs.)
- 26.75.002 (1 kom/pcs.)

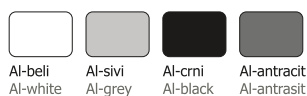

Dimenzije za montažu
 Mounting Size

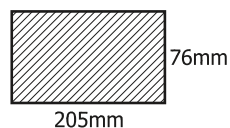



Office-Ca

Sklop utičnica za stolove (dvosmerno otvaranje) - 6 utičnice+1cat6+1cat3+1HDMI
 Desktop socket system (Two way opening) - 6 socket+1cat6+1cat3+1HDMI

Broj artikla / Article No.:

- 26.01.003 (1 kom/pcs.)
- 26.23.003 (1 kom/pcs.)
- 26.15.003 (1 kom/pcs.)
- 26.75.003 (1 kom/pcs.)

- Al-beli
Al-white
- Al-sivi
Al-grey
- Al-crni
Al-black
- Al-antracit
Al-antrasit

Dimenzije za montažu
Mounting Size

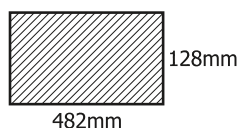

Office-Pn

Sklop utičnica za stolove (dvosmerno otvaranje) - 2 utičnice+1UPS+1cat6+1cat3+1,5m kabl
 Desktop socket system (Two way opening) - 2 socket+1UPS+1cat6+1cat3+1,5m cable

Broj artikla / Article No.:

- 26.01.004 (1 kom/pcs.)
- 26.23.004 (1 kom/pcs.)
- 26.15.004 (1 kom/pcs.)
- 26.75.004 (1 kom/pcs.)

- Al-beli
Al-white
- Al-sivi
Al-grey
- Al-crni
Al-black
- Al-antracit
Al-antrasit

Dimenzije za mo
Mounting Size

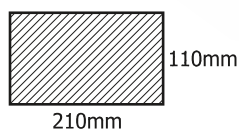



Office-Ec

Pop-up utičnica - 2 utičnice+1cat6+1cat3+1,5m kabl
Pop-up socket outlet - 2 socket+1cat6+1cat3+1,5m cable

Broj artikla / Article No.:

- A. 26.72.001 (1 kom/pcs.)
- B. 26.72.002 (1 kom/pcs.)
- C. 26.72.003 (1 kom/pcs.)

Dimenzije za montažu
Mounting Size

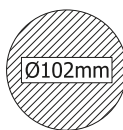

26.72.001
26.72.002



26.72.003



Office-S

Okrugli sklop utičnica od nerdjajućeg čelika - 2 utičnice+1cat3+1cat6
Stainless steel round socket system - 2 socket+1cat3+1cat6

Broj artikla / Article No.:

- 26.01.005 (1 kom/pcs.)
- 26.23.005 (1 kom/pcs.)
- 26.15.005 (1 kom/pcs.)
- 26.75.005 (1 kom/pcs.)

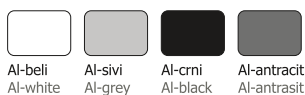

Dimenzije za montažu
Mounting Size





Office-SR

Okrugli sklop utičnica - 2 utičnice
Round socket system - 2 socket

Broj artikla / Article No.:

- 26.01.006 (1 kom./pcs.)
- 26.23.006 (1 kom./pcs.)
- 26.15.006 (1 kom./pcs.)
- 26.75.006 (1 kom./pcs.)

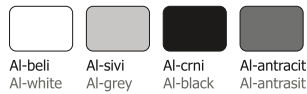

Dimenzije za montažu
Mounting Size

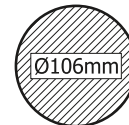

Office-M

Dimenzije za montažu
Mounting Size

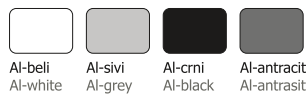
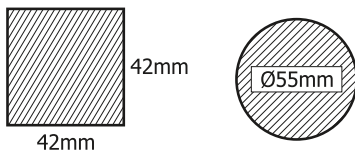

USB konektor-okrugli
USB connector-round

Broj artikla / Article No.:

- 26.01.007 (1 kom./pcs.)
- 26.23.007 (1 kom./pcs.)
- 26.15.007 (1 kom./pcs.)
- 26.75.007 (1 kom./pcs.)



USB konektor-črtvrtasti
USB connector-square

Broj artikla / Article No.:

- 26.01.008 (1 kom./pcs.)
- 26.23.008 (1 kom./pcs.)
- 26.15.008 (1 kom./pcs.)
- 26.75.008 (1 kom./pcs.)



Office-G

Modularni sklop (2-24 modula različitih dimenzija i kombinacija)
Modular power strip extension (manufactured between 2-24 modules with different dimensions)

Broj artikla / Article No.:

- 26.01.009 (1 kom./pcs.)





BATHROOM FAN

FLUENT 



Ventilator za kupatilo-Fluent 100
Bathroom fan-Fluent 100

Broj artikla / Article No.:
35.01.100

Pakovanje / Pack:
1 kom / pcs.

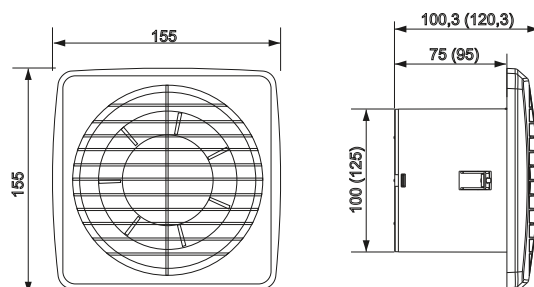

Tehničke karakteristike/ Technical characteristics	Protok vazduha / Air flow	Statički pritisak / Static pressure	Nivo buke / Acoustic pressure	Brzina / Speed	Napon / Voltage	Snaga / Power	Potrošnja struje / Current consumption
FLUENT 100	[m ³ /h] 100	[Pa] 34	[dB(A)] 40	[ob/min] 2400	[V/Hz] 230/50	[W] 15	[A] 0,12

FLUENT 



Ventilator za kupatilo-Fluent Panel 100
Bathroom fan-Fluent Panel 100

Broj artikla / Article No.:
36.01.100

Pakovanje / Pack:
1 kom / pcs.

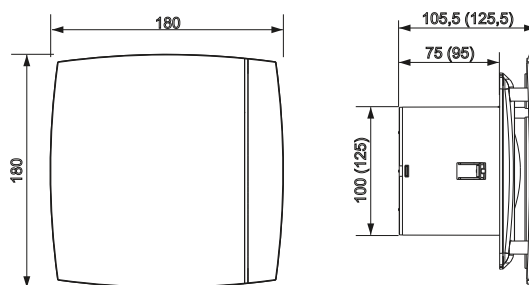

Tehničke karakteristike/ Technical characteristics	Protok vazduha / Air flow	Statički pritisak / Static pressure	Nivo buke / Acoustic pressure	Brzina / Speed	Napon / Voltage	Snaga / Power	Potrošnja struje / Current consumption
FLUENT P 100	[m ³ /h] 100	[Pa] 34	[dB(A)] 40	[ob/min] 2400	[V/Hz] 230/50	[W] 15	[A] 0,12

PLASTIC BOX FOR PLUMBING AND HEATING



Plastični razvodni ormarić za
vodu i grejanje
400x400x95mm
Plastic box for plumbing
and heating
400x400x95mm

Flush assembling

Broj artikla / Article No.:
08.12.01

Pakovanje / Pack:
1 kom / pcs.



Plastični razvodni ormarić za
vodu i grejanje
500x400x95mm
Plastic box for plumbing
and heating
500x400x95mm

Flush assembling

Broj artikla / Article No.:
08.13.01

Pakovanje / Pack:
1 kom / pcs.

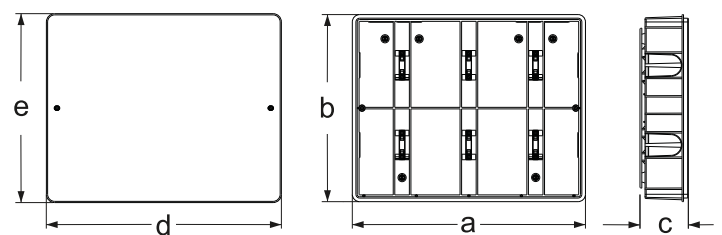

	a (mm)	b (mm)	c (mm)	d (mm)	e (mm)
400x400	406	406	105	410	410
500x400	506	406	105	510	410

uputstvo za montažu mounting instructions

Priključenje provodnika kod priključnica vrši se pomoću vijaka. Priključenje provodnika kod sklopki, zavisno od tipa njihovog priključka, vrši se pomoću vijaka ili jednostavnim umetanjem blankiranog dela provodnika (dela provodnika sa skinutom izolacijom) u predviđeni otvor. U slučaju vađenja provodnika iz sklopke sa bezvijačnim priključkom potrebno je pritisnuti odgovarajuće dugme čime se provodnik oslobađa iz opružnog kontakta i jednostavno izvuče.

Wiring of a socket outlet is performed by screws. Wiring of a switch depends of switch type (screwless or with screws), and is performed by screws or by simple introduction of blanked wire end (the end with removed insulation) into appropriate gap, following the wiring scheme. In case that the wire should be disconnected from the screwless switch, it is necessary to push the corresponding button, thus releasing the wire from the clamp and then simply draw out the wire.

Sklopke za ugradnju u zid:

1. Isključiti dovod električne energije (osigurač, glavna sklopka);
2. Skinuti tipkalo(a), uklopni i ukrasni okvir sklopke;
3. Pripremiti provodnike za sklopku (skinuti izolaciju u dužini od 10mm);
4. Izvršiti povezivanje pripremljenih provodnika prema odgovarajućoj shemi veze;
5. Podsklopku postaviti u doznu, poravnati ga i pritegnuti vijke na šapicama;
6. Montirati ukrasni i uklopni okvir i tipkalo(a);
7. Uključiti dovod električne energije;

Flush-assembling switches

1. Switch off power supply (safety fuse, the mains);
2. Remove the push-button(s) and built-in, decorative frame;
3. Prepare the wires for connection (remove insulation in length of 10 mm);
4. Connect the prepared wires according to the given wiring scheme;
5. Put the switch subassembly into mounting box, level it and fasten the screws;
6. Mount both built-in, decorative frame and the push button(s);
7. Switch on power supply.

Priključnice za ugradnju u zid:

1. Isključiti dovod električne energije (osigurač, glavna sklopka);
2. Odviti centralni vijak na poklopcu priključnice i skinuti poklopac;
3. Pripremiti provodnike za priključnicu (skinuti izolaciju u dužini od 10mm);
4. Izvršiti povezivanje pripremljenih provodnika prema odgovarajućoj shemi veze;
5. Podsklopku priključnice postaviti u doznu, poravnati ga i pritegnuti vijke na šapicama;
6. Montirati poklopac priključnice;
7. Uključiti dovod električne energije;

Flush-assembling socket-outlets

1. Switch off power supply (safety fuse, the mains);
2. Unscrew the cover central screw and remove the cover;
3. Prepare the wires for connection (remove insulation in length of 10 mm);
4. Connect the prepared wires according to the given wiring scheme;
5. Put the socket subassembly into mounting box, level it and fasten the screws;
6. Mount the socket cover;
7. Switch on power supply;

Montažu treba da izvrši stručno lice!
INSTALLATION CAN BE DONE ONLY BY PROFESSIONALLY TRAINED PERSON!

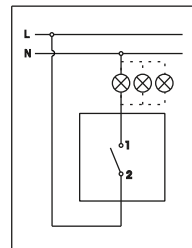

Jednopolna sklopka
Single-pole switch

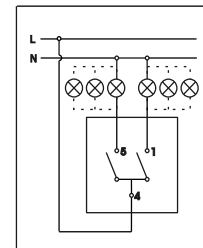

Serijska sklopka
Two-circuit switch

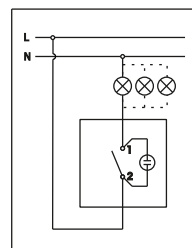

Jednopolna sklopka sa signalnom sijalicom
Single-pole switch with pilot light

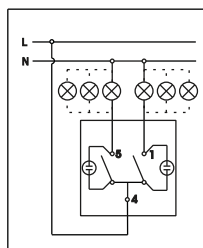

Serijska sklopka sa signalnom sijalicom
Two-circuit switch with pilot lights

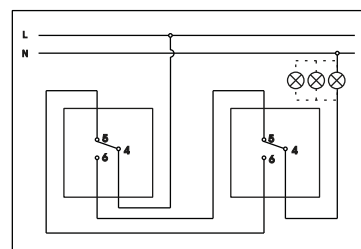

Naizmenična sklopka
Two-way switch

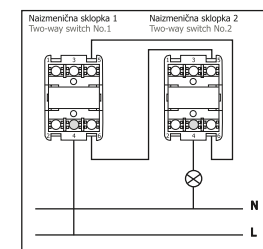

Povezivanje dve naizmenične sklopke
Wiring of two-way switches

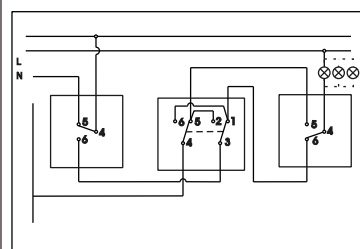

Unakrsna sklopka
Intermediate switch

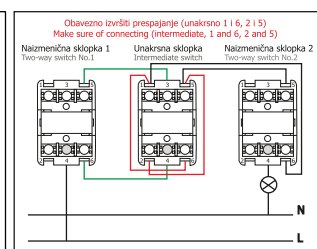

Povezivanje unakrsne sklopke
Wiring of intermediate switch

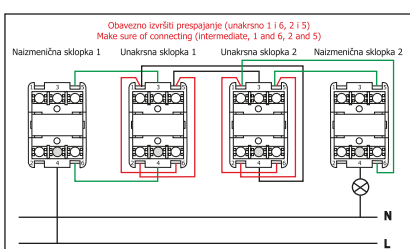

Povezivanje dve unakrsne sklopke
Wiring of two intermediate switches

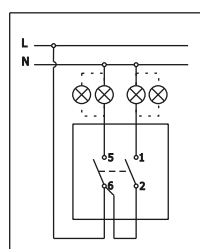

Dvopolna sklopka
Double-pole switch

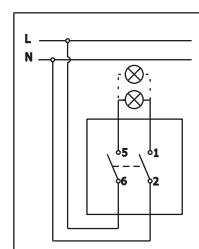

Dvopolna sklopka
Double-pole switch

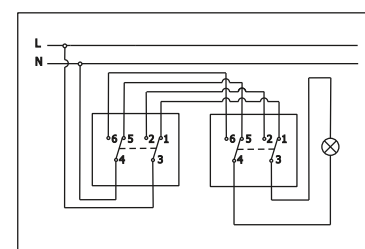

Dvopolna naizmenična sklopka
Two-way double-pole switch

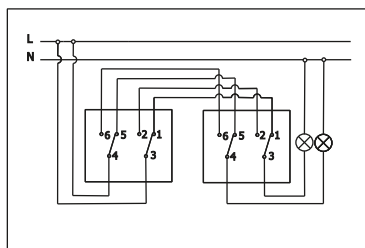

Dvostruka naizmenična sklopka
Double two-way switch

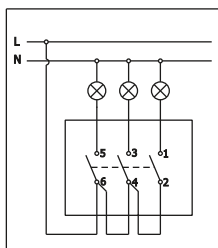

Tropolna sklopka
Three-pole switch

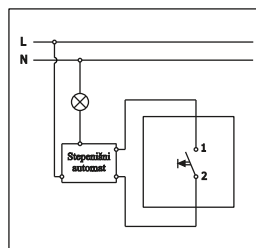

Taster svetla
Light push-button

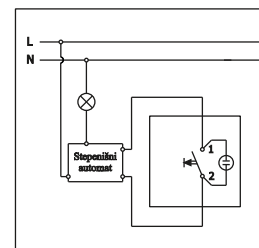

Taster svetla sa signalnom sijalicom
Light push-button with pilot light

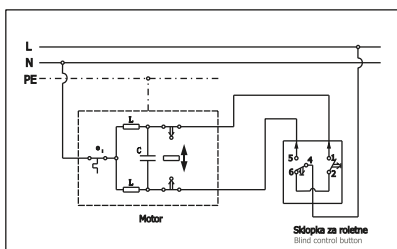

Taster za roletne i motor
Wiring of blind control button and motor

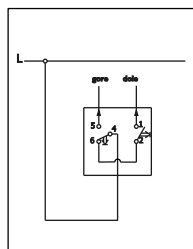

Taster za roletne
Blind control button

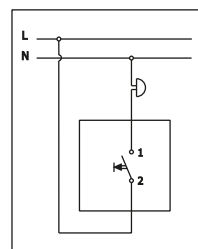

Taster zvona
Bell push-button

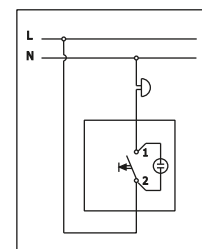

Taster sa signalnom sijalicom
Push-button with pilot light

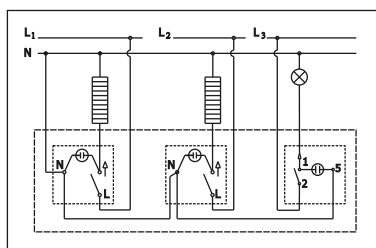

Vertikalna sklopka za kupatilo
Vertical bathroom switch

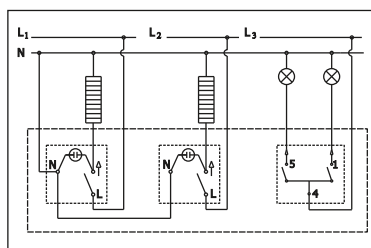

Vertikalna sklopka za kupatilo sa serijskom sklopkom
Vertical bathroom switch with two-circuit switch

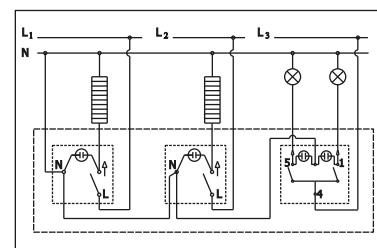

Vertikalna sklopka za kupatilo sa serijskom sklopkom i signalnim sijalicama
Vertical bathroom switch with two-circuit switch and pilot lights

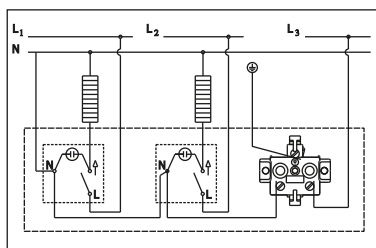

Vertikalna sklopka za kupatilo sa dvopolnom priključnicom
Vertical bathroom switch with two-pole socket-outlet

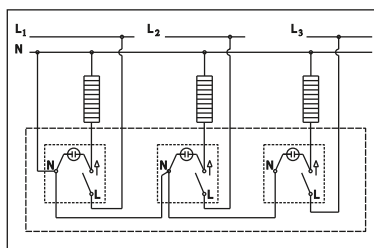

Horizontalna sklopka za kupatilo
Horizontal bathroom switch

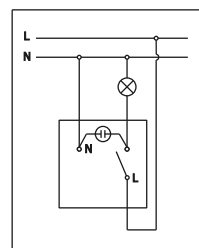

Jednopolna sklopka (KIP)
Single-pole switch (KIP)

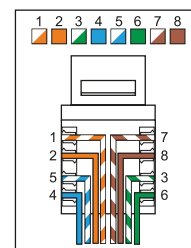

Komunikaciona Cat6 UTP
Communication socket Cat6 UTP

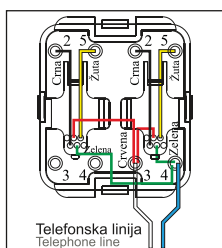

Telefonska priključnica
Telephone socket

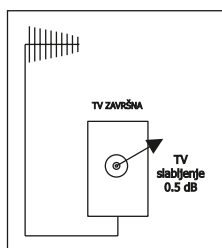

TV priključnica 1M završna
TV aerial socket 1M terminal

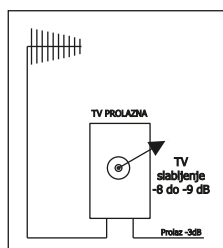

TV priključnica 1M prolazna
TV aerial socket 1M feed through

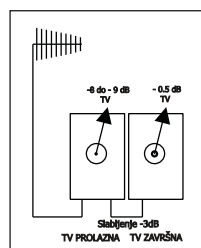

TV priključnica 2M prolazno završna
TV aerial socket 2M feed through & terminal

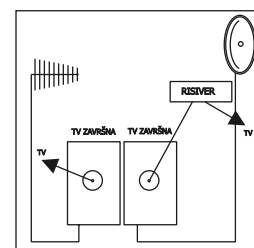

TV priključnica 2M završna
TV aerial socket 2M terminal

uputstvo za montažu mounting instructions

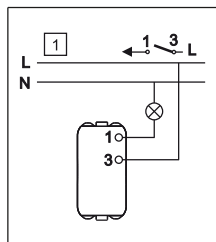

Kombo - Jednopolna sklopka
Kombo - Single-pole switch - wiring

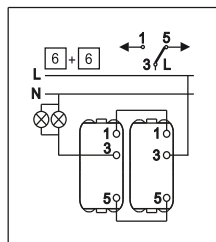

Kombo - Naizmjenična sklopka
Kombo - Two-way switch - wiring

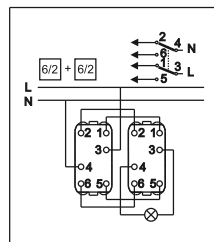

Kombo - Dvopolna naizmjenična sklopka
Kombo - Two-way double-pole switch - wiring

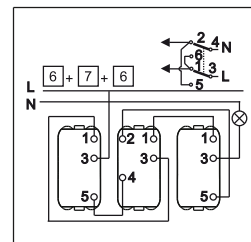

Kombo - Unakrsna sklopka
Kombo - Intermediate switch - wiring

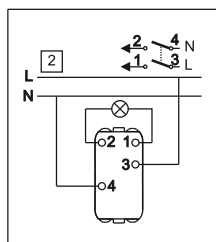

Kombo - Dvopolna sklopka
Kombo - Double-pole switch - wiring

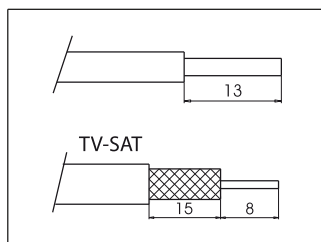

Kombo - Blankiranje provodnika za TV priključnice
Kombo - Removing isolation for TV aerial sockets

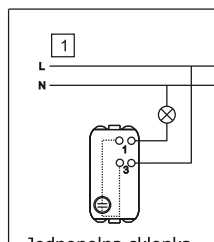

Jednopolna sklopka
Single-pole switch

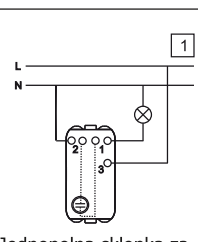

Jednopolna sklopka za kupatilo
Single-pole switch with zero contact

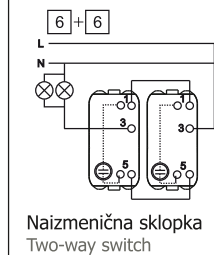

Naizmjenična sklopka
Two-way switch

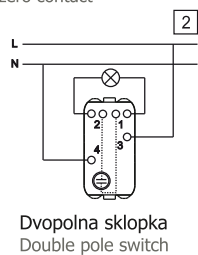

Dvopolna sklopka
Double pole switch

Tinjalica svjetli - potrošač isključen
Neon lamp ON-switch OFF

Tinjalica svjetli - potrošač isključen
Neon lamp ON-switch OFF

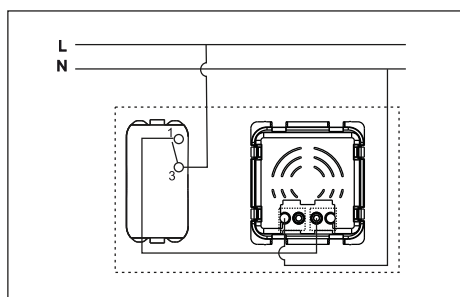

Kombo LED - Jednopolna sklopka + LED u istoj montažnoj kutiji
Kombo LED - Single pole switch + LED in the same mounting box

Kombo - šeme vezivanja tinjalica
Kombo - wiring of lamps

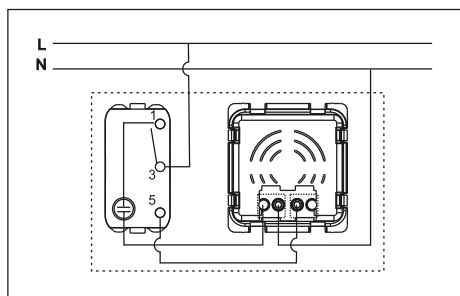

Kombo LED - Naizmjenična sklopka sa tinjalicom + LED u istoj montažnoj kutiji
Kombo LED - Two-way switch with diffuser + LED in the same mounting box

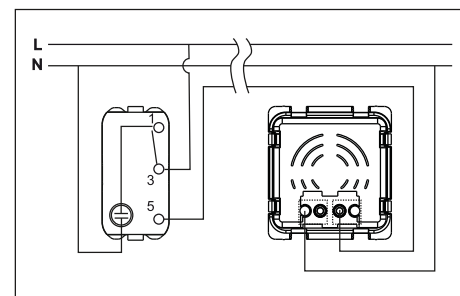

Kombo LED - Naizmjenična sklopka sa tinjalicom + LED u različitim montažnim kutijama
Kombo LED - Two-way switch with diffuser + LED in the different mounting boxes



Važno ! / Important !

Montažu može vršiti samo stručno obučena osoba !

Installation can be done only by professionally trained person !

uputstvo za montažu mounting instructions

Montaža horizontalnog nizajućeg okvira
 Mounting of horizontal decorative frames

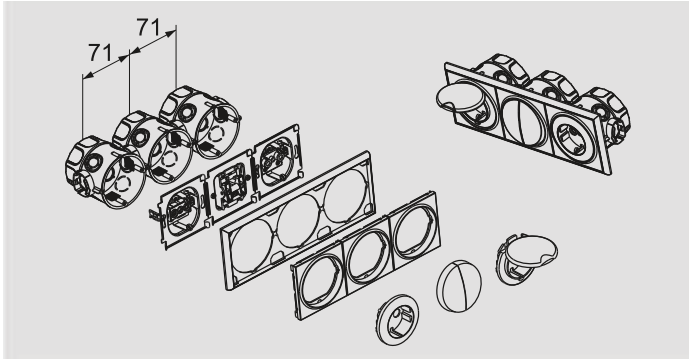

Montaža vertikalnog nizajućeg okvira
 Mounting of vertical decorative frames

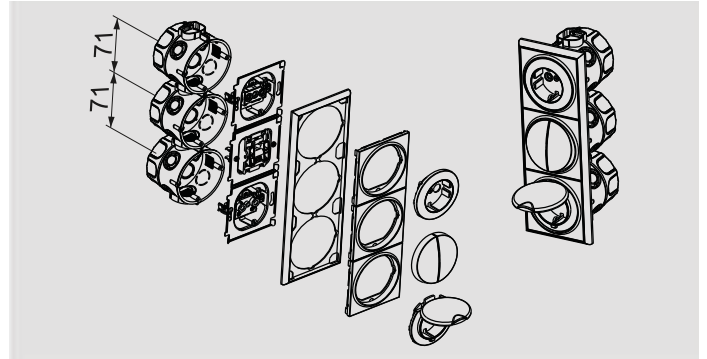

Montaža nizajuće dozne
 Mounting box for multiple frames - deep

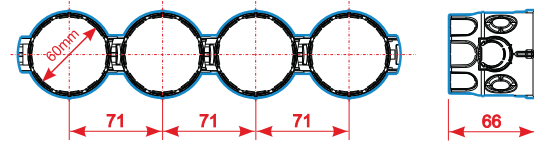
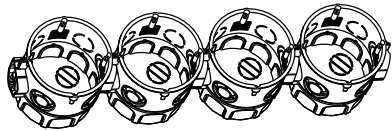

Montaža razvodnih tabli / Mounting Distribution panels

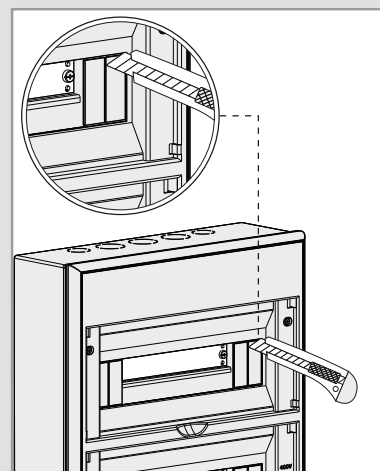
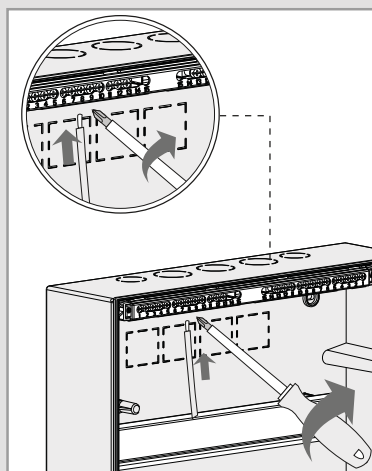
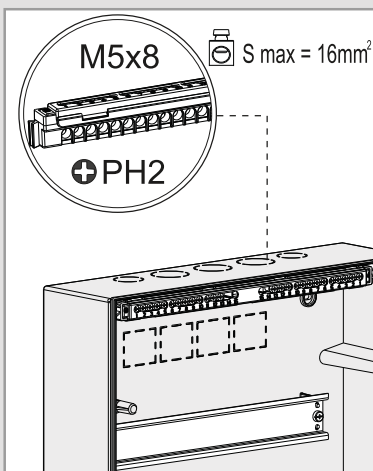
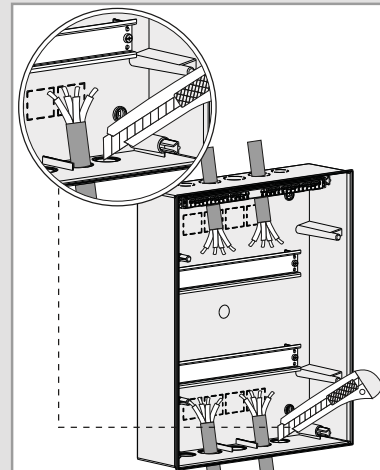
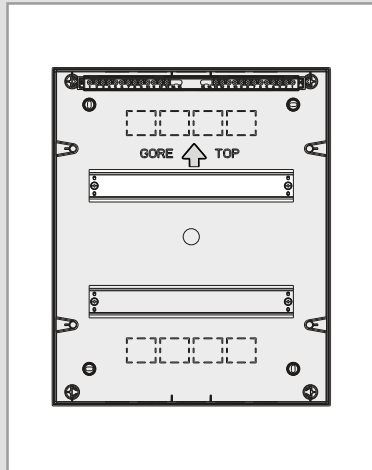
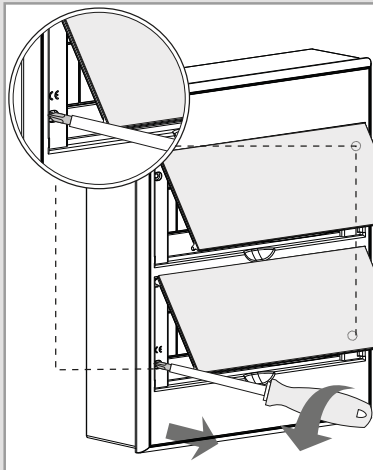

technical details

Switches have terminals which allow secure connection of copper conductors with the following rated surfaces:

Rated current of a switch (A)	Type of connection	Solid conductors (single-wire and multi-wire)	
		Rated surface of cross section of a conductor mm ²	Diameter of the biggest conductor mm ²
10	Connection with screws	Od 1 do 2,5	2,13
10	Screwless connection	Od 1,5 do 2,5	2,13
16	Connection with screws	Od 1,5 do 4	2,72
16	Screwless connection	Od 1,5 do 2,5	2,13

No.	Characteristic	Product	Standard	Data
1	Insulation resistance	Switches 10A and 16A	IEC 60669-1	>5MΩ at 500Vdc, 1min
		Socket-outlet 16A	IEC 60884-1	
2	Dielectric strength	Switches 10A and 16A	IEC 60669-1	2000V~ at 50Hz, 1min
		Socket-outlet 16A	IEC 60884-1	
3	Making and breaking capacity	Switches 10A	IEC 60669-1	100 cycles at 12,5A; 275V; cosφ=0,3±0,05
		Switches 16A	IEC 60669-1	100 cycles at 20A; 275V; cosφ=0,3±0,05
4	Breaking capacity	Socket-outlet 16A	IEC 60884-1	50 cycles at 20A; 275V; cosφ=0,6±0,05
5	Normal operation	Switches 10A	IEC 60669-1	20 000 cycles at 10A; 250V; cosφ=0,6±0,05
		Switches 16A		20 000 cycles at 16A; 250V; cosφ=0,6±0,05
		Socket-outlet 16A	IEC 60884-1	5 000 cycles at 16A; 250V; cosφ=0,8±0,05
6	Resistance to heat	Switches 10A and 16A	IEC 60669-1	100±2°C, in a heating cabinet 1h
		Socket-outlet 16A	IEC 60884-1	
7	Ball pressure test	Switches 10A and 16A	IEC 60669-1	125°C - inside parts of insulating material
		Socket-outlet 16A	IEC 60884-1	70°C - outer parts of insulating material
8	Glow wire test	Switches 10A and 16A	IEC 60695-2-1	850°C - inside parts of insulating material
		Socket-outlet 16A		650°C - outer parts of insulating material
9	Resistance to tracking	Switches 10A and 16A	IEC 60112	175V, 30s±5s
		Socket-outlet 16A		
10	Resistance to rusting	Switches 10A and 16A	IEC 60669-1	Resistant
		Socket-outlet 16A	IEC 60884-1	



